

**SINGER**  
**191K1,K2,K3**

ILLUSTRATED  
LIST OF PARTS  
FOR  
Nos. 191K1 to 191K3  
MACHINES

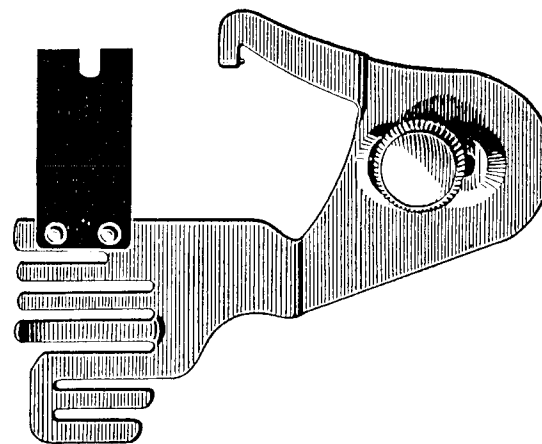

121170



121547

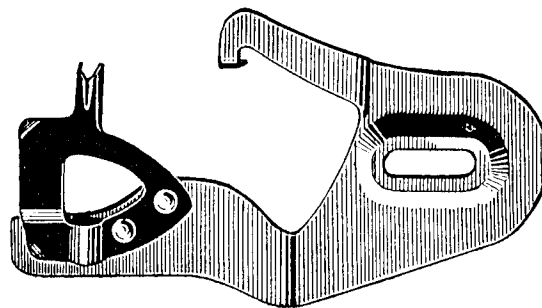

From the library of: Diamond Needle Corp

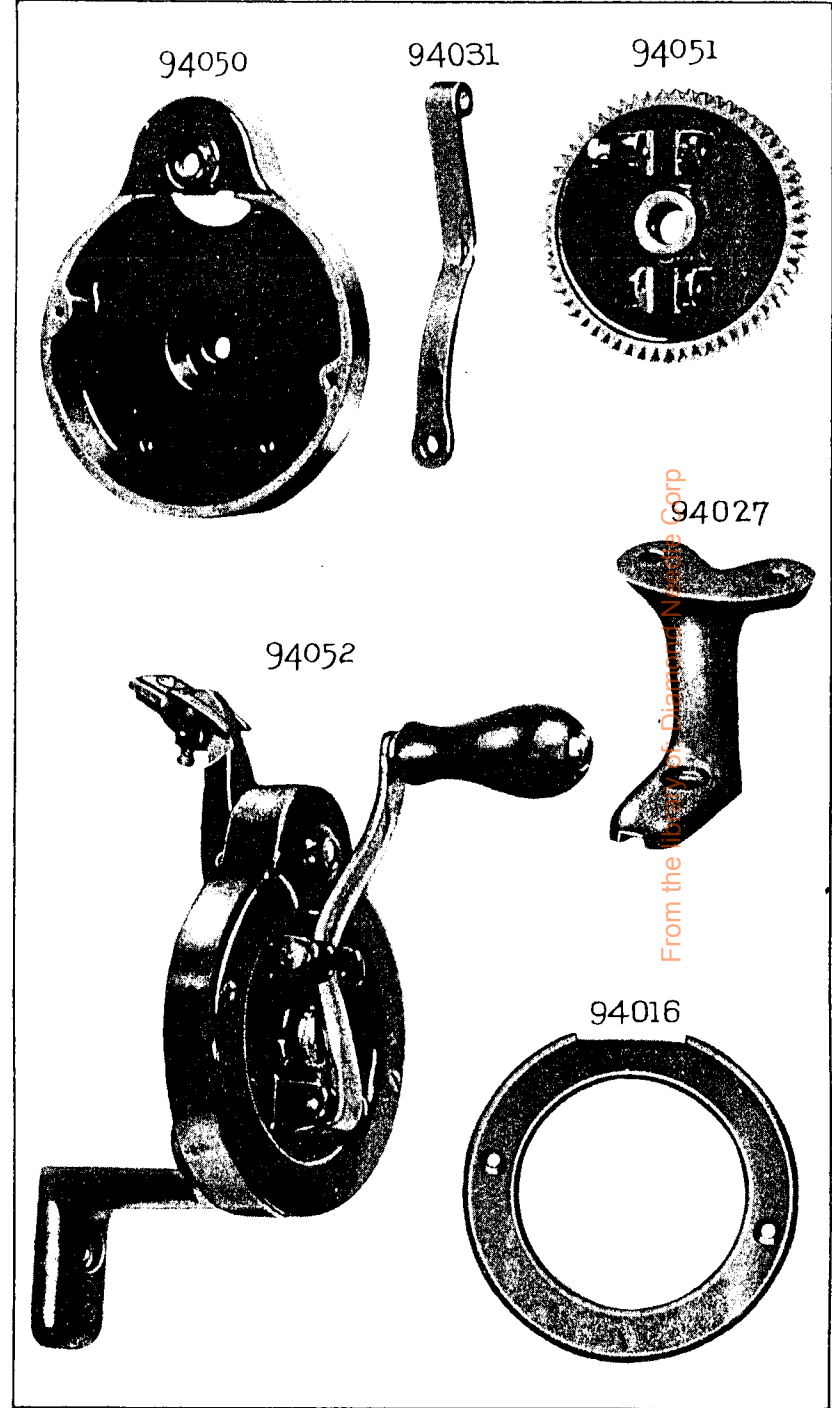
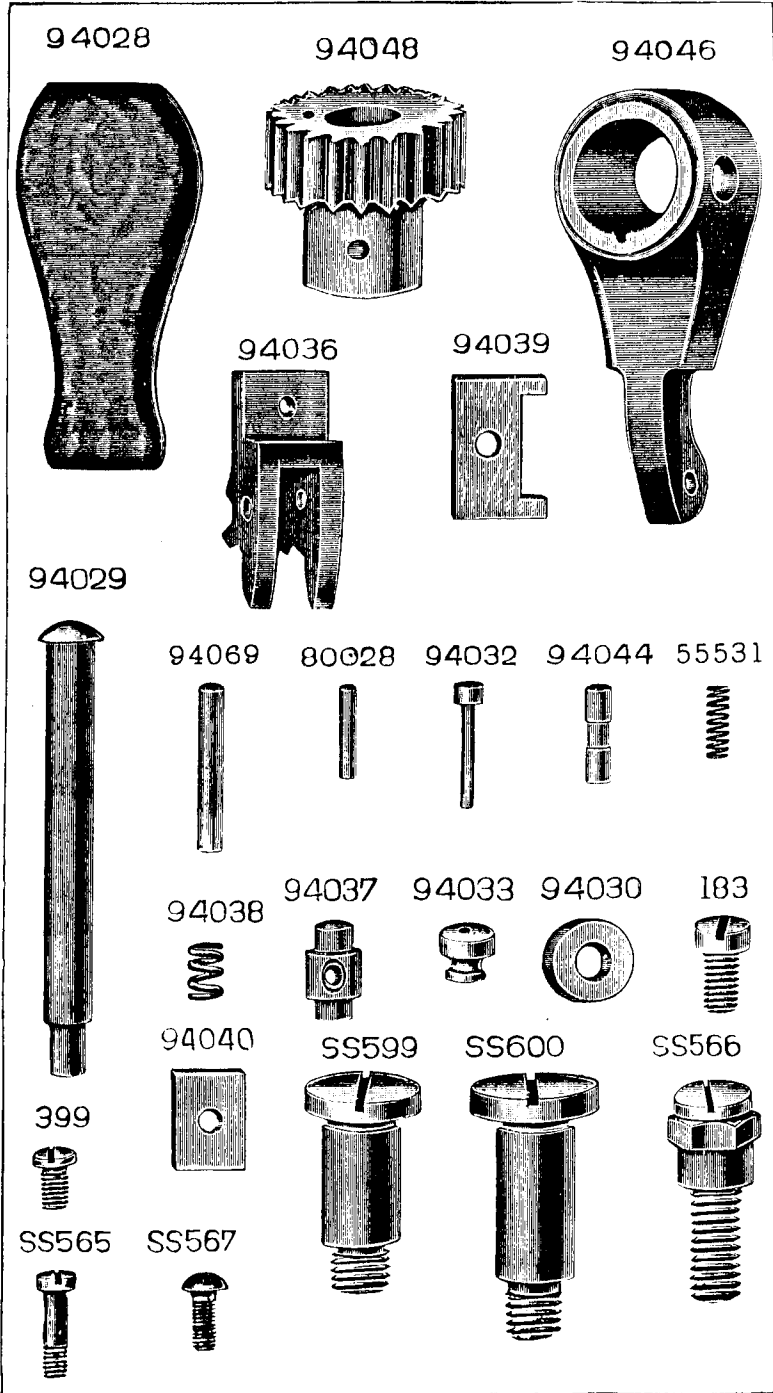

From the files of the Division of Ordnance

SS 528



96425



96426



96844

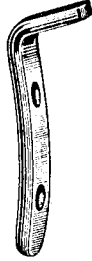

96427



96845



W95



86742

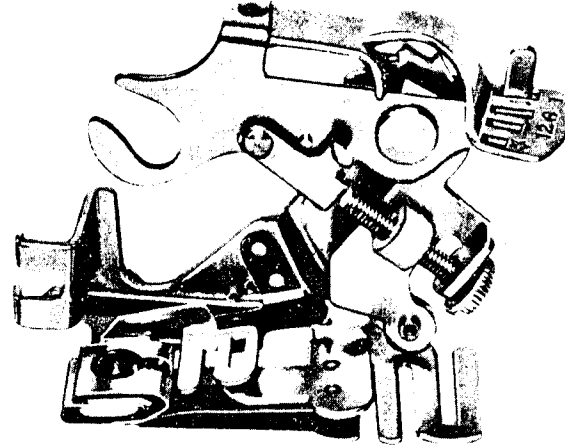

121441



36865

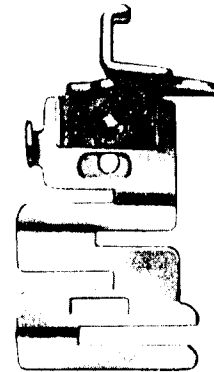

121464

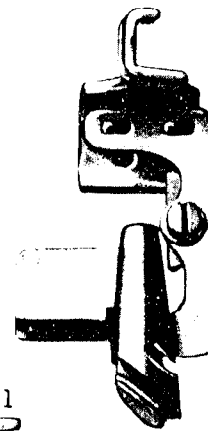

161295



161294



35931

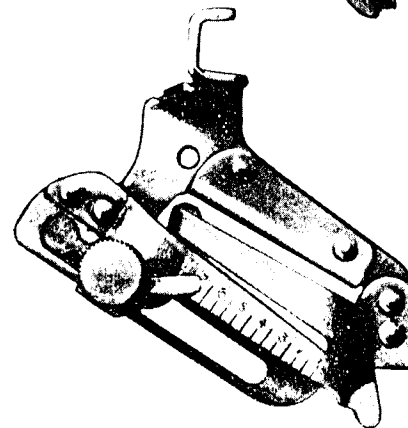

8879

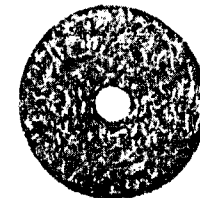

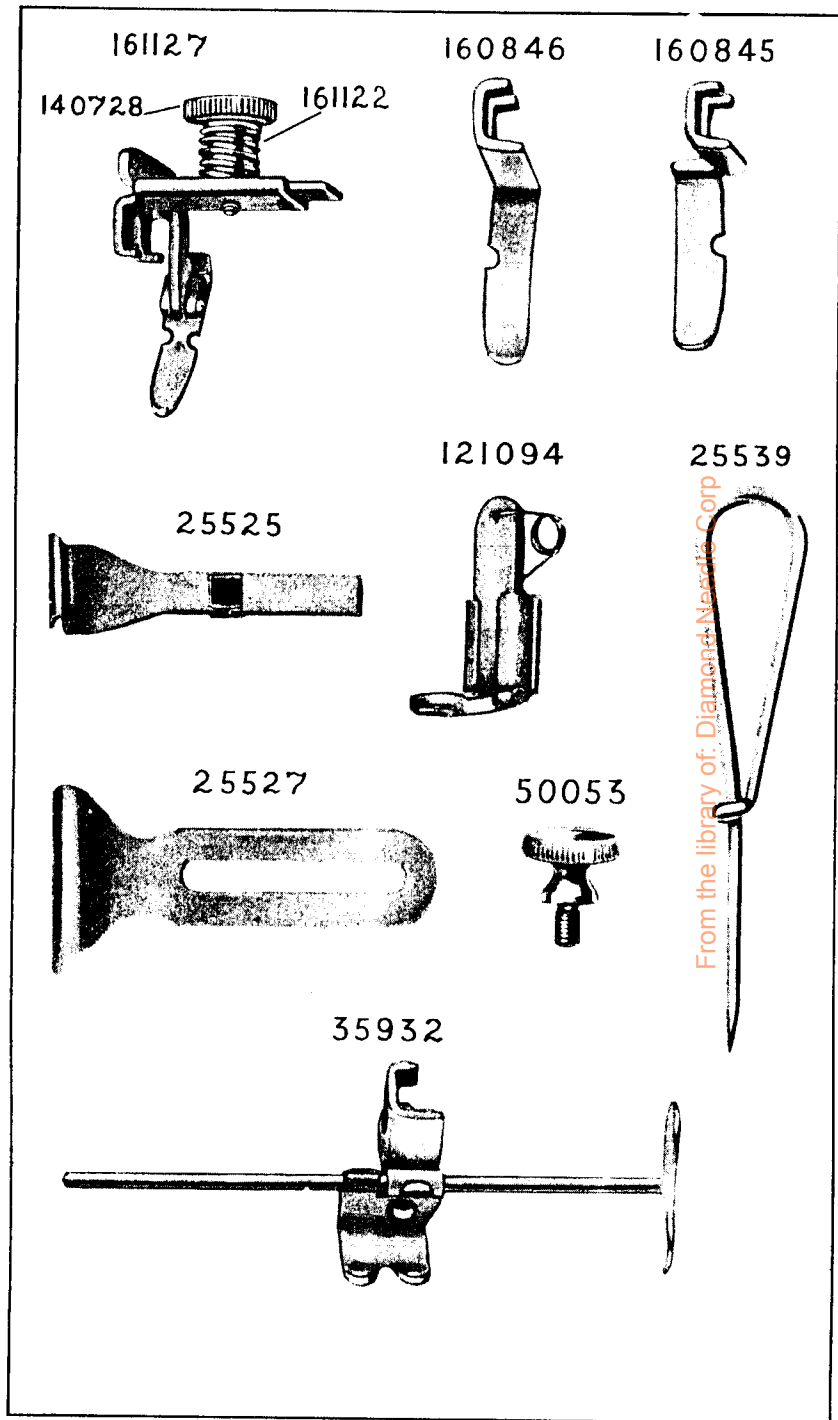
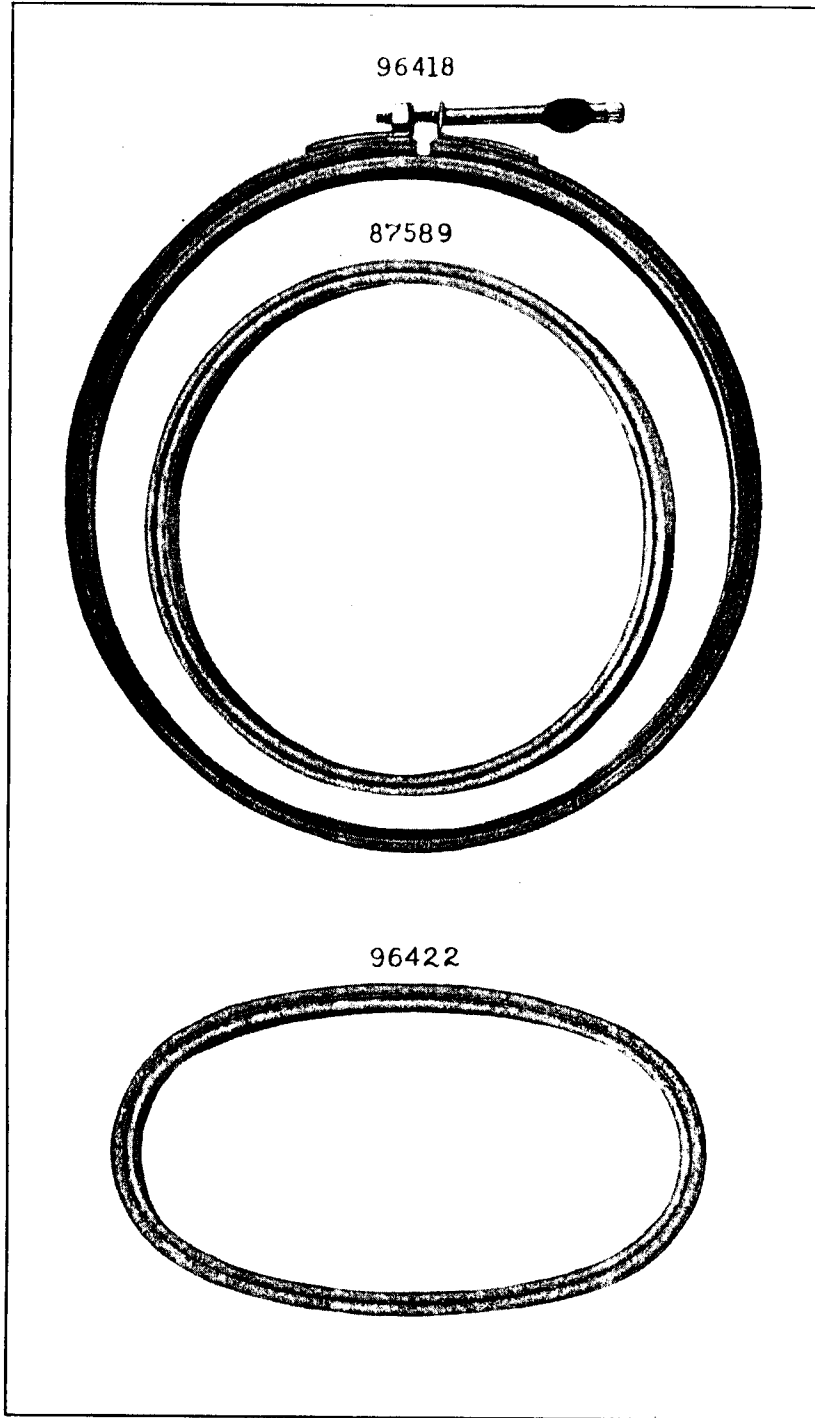



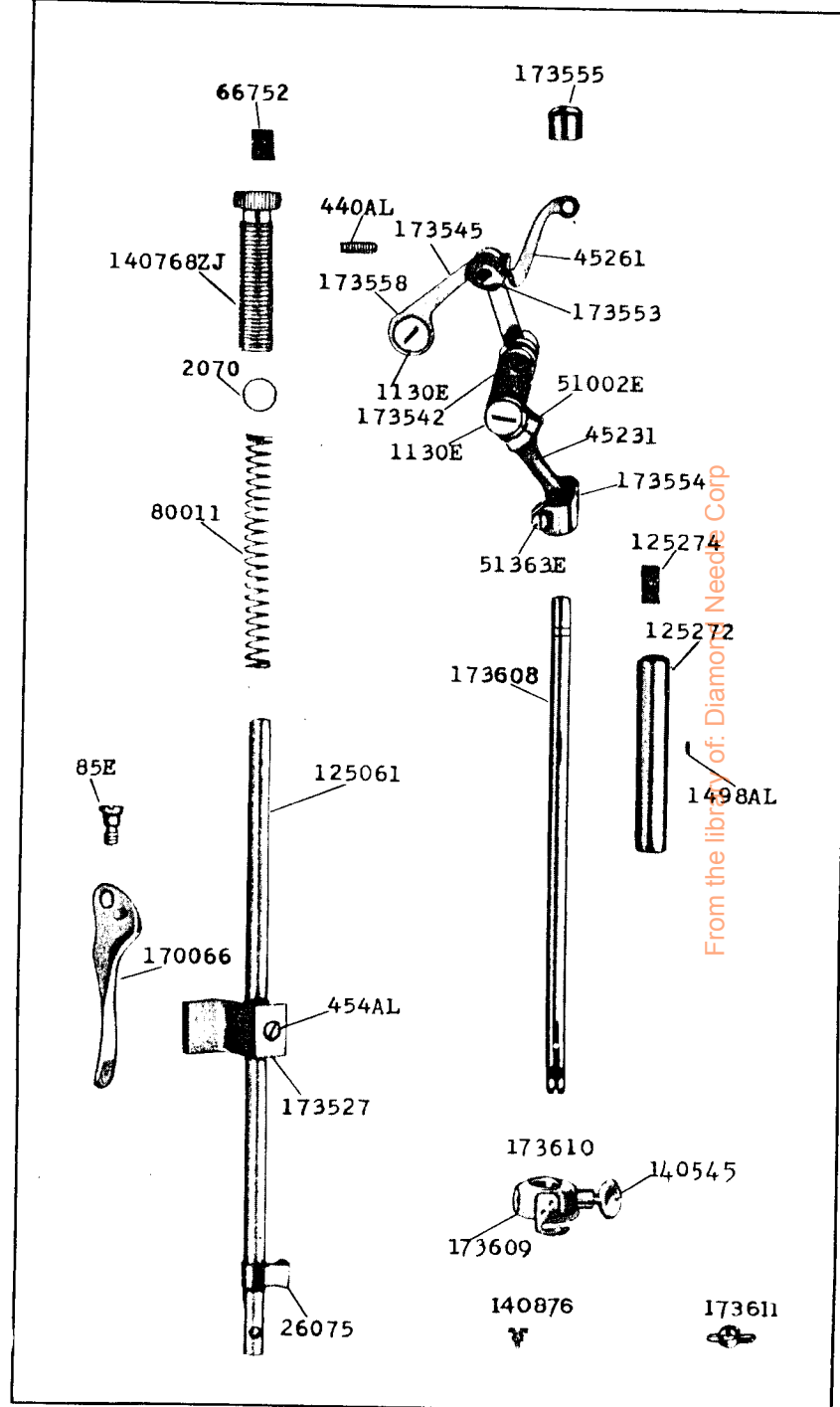
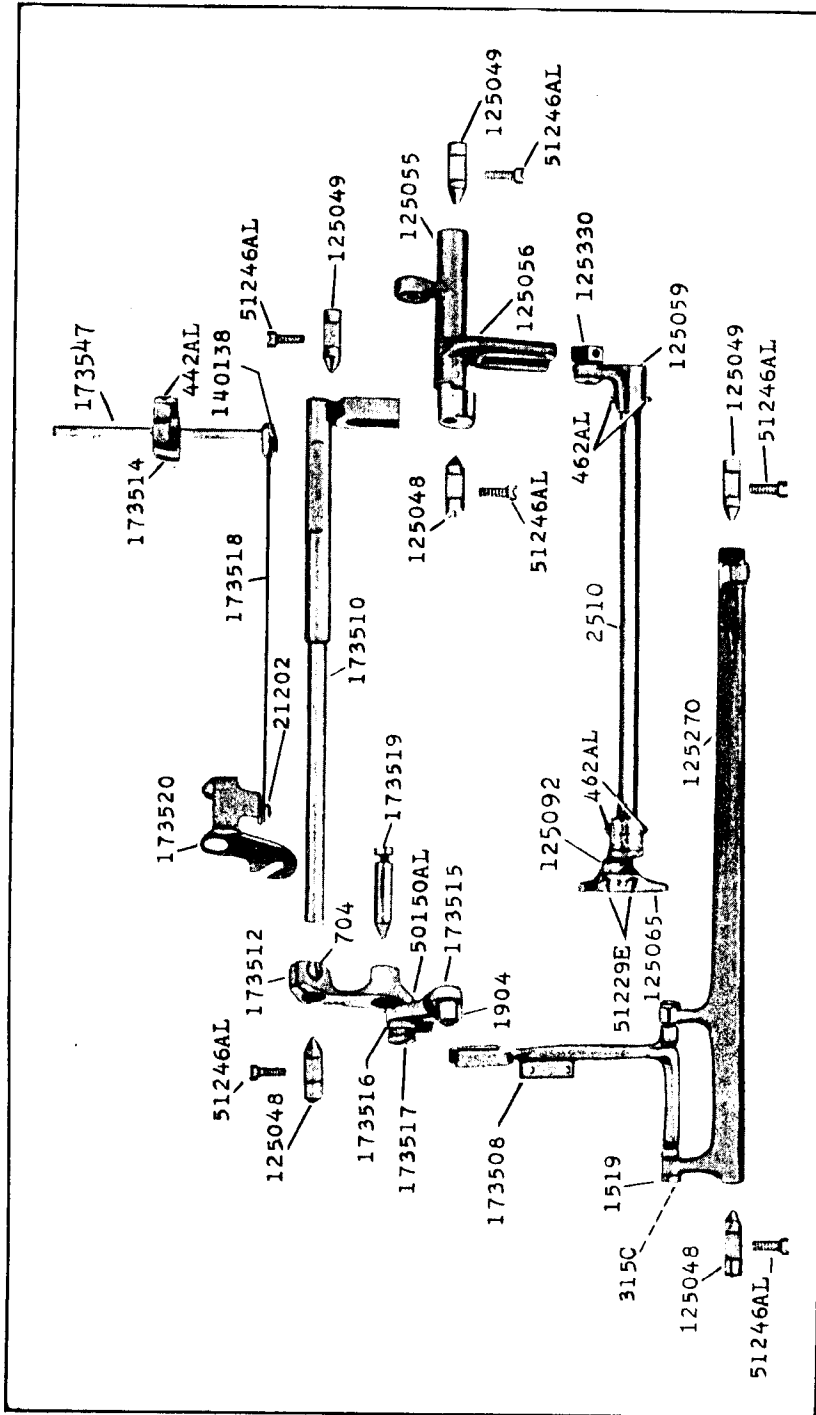

From the library of: Diamond Needs Corp

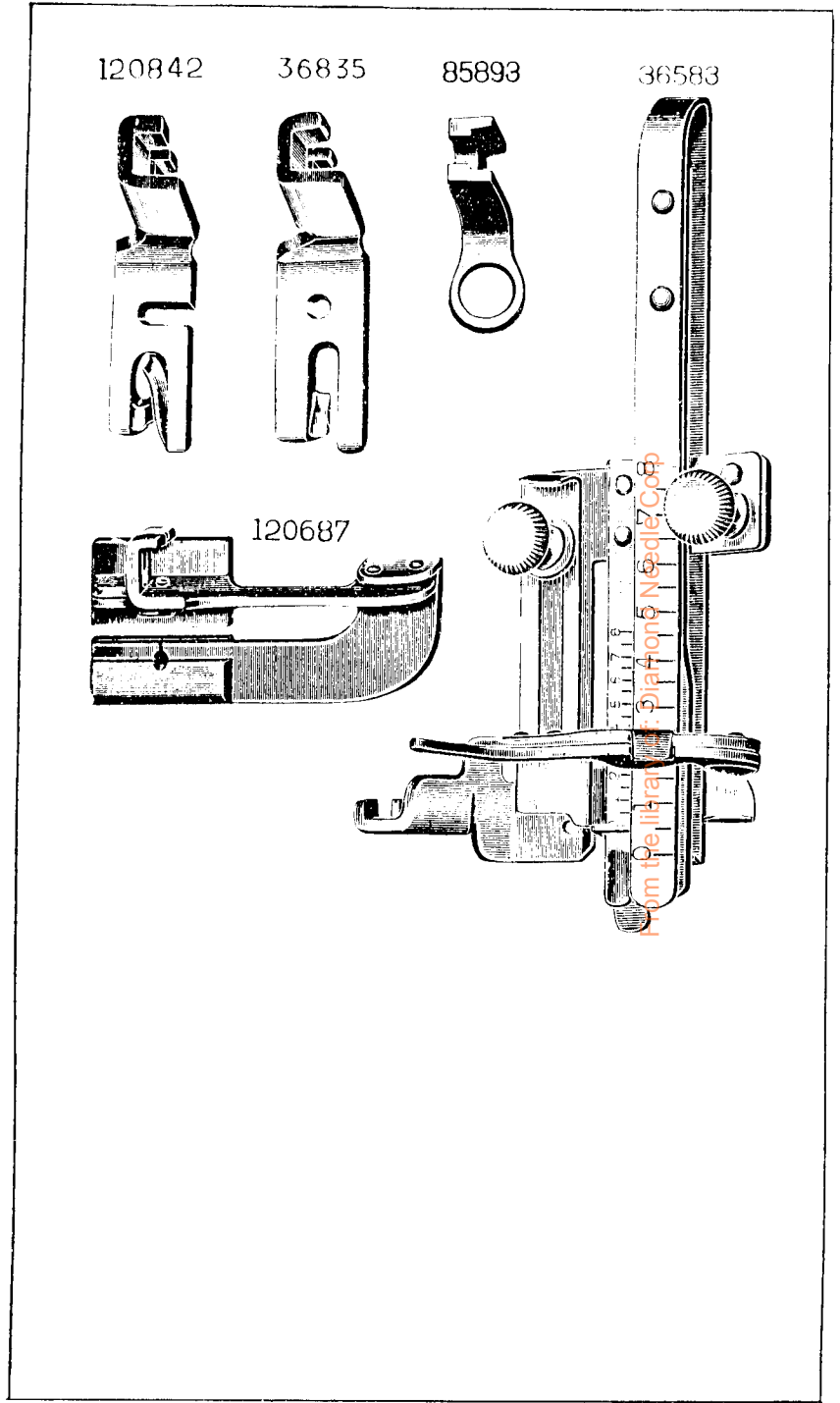
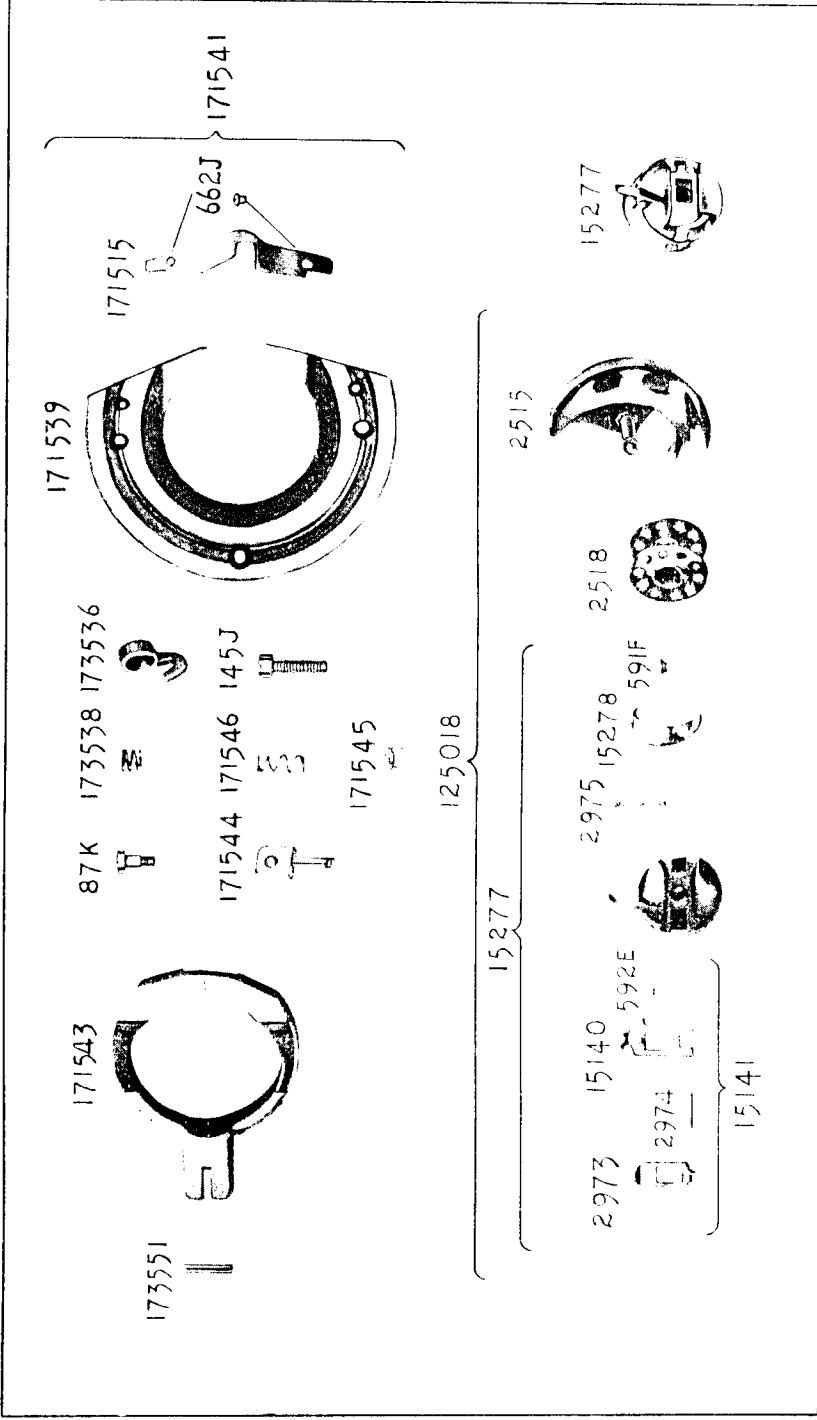



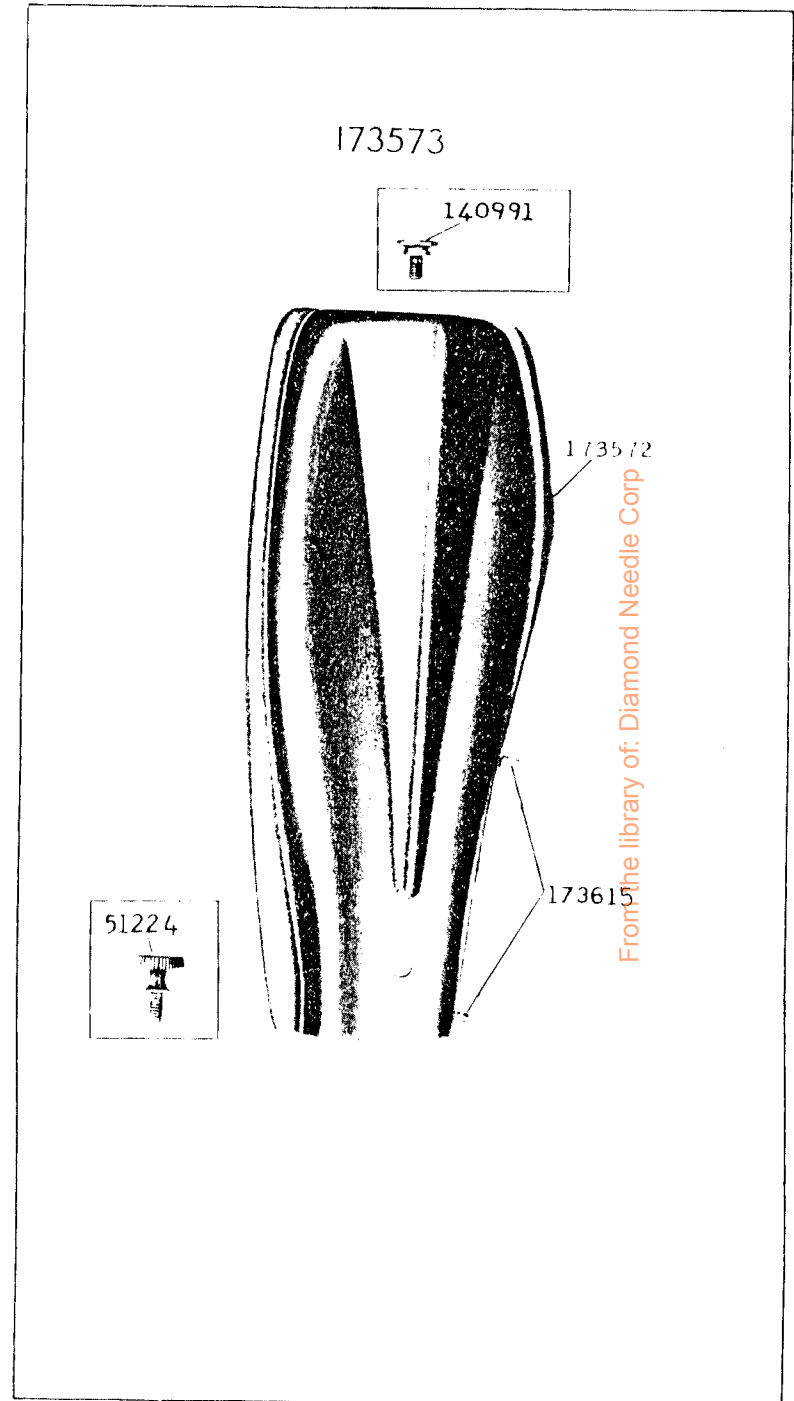
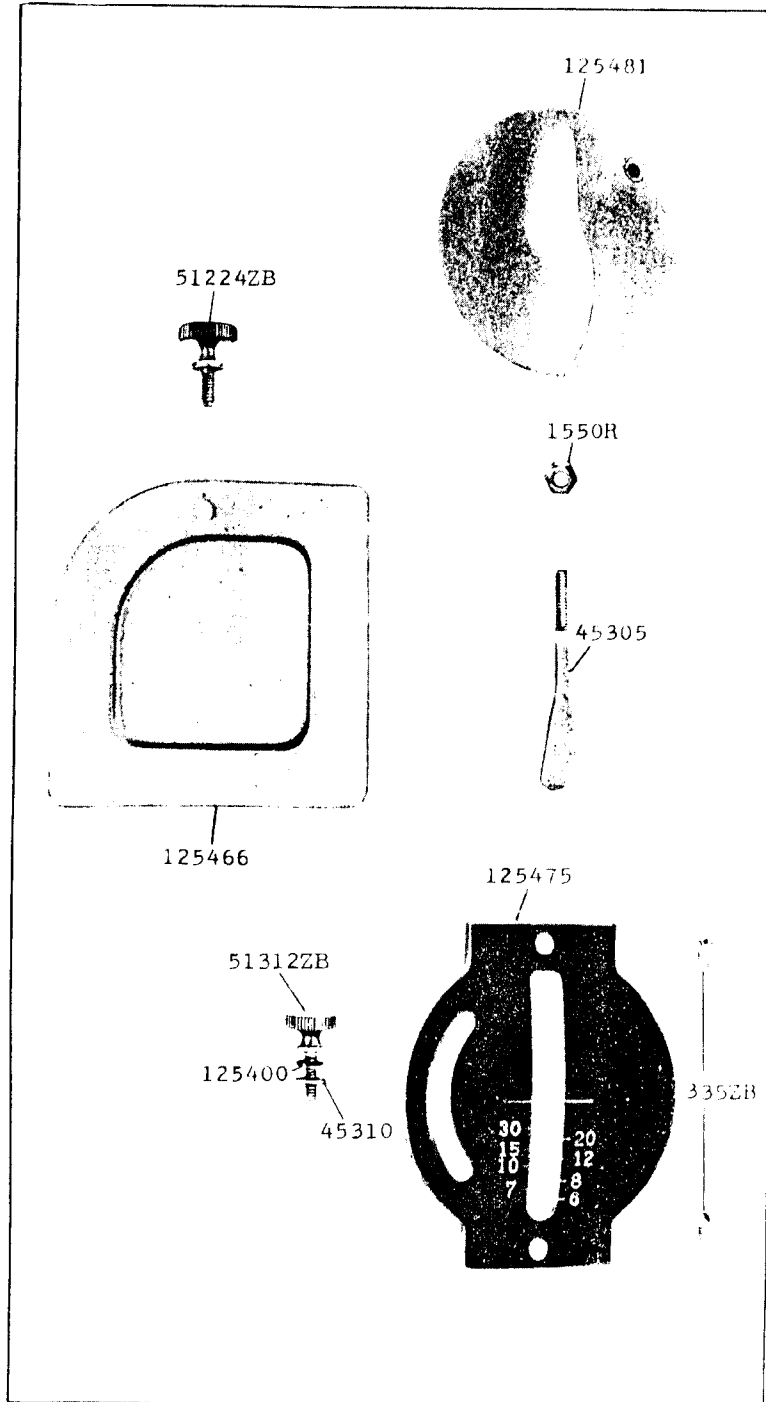

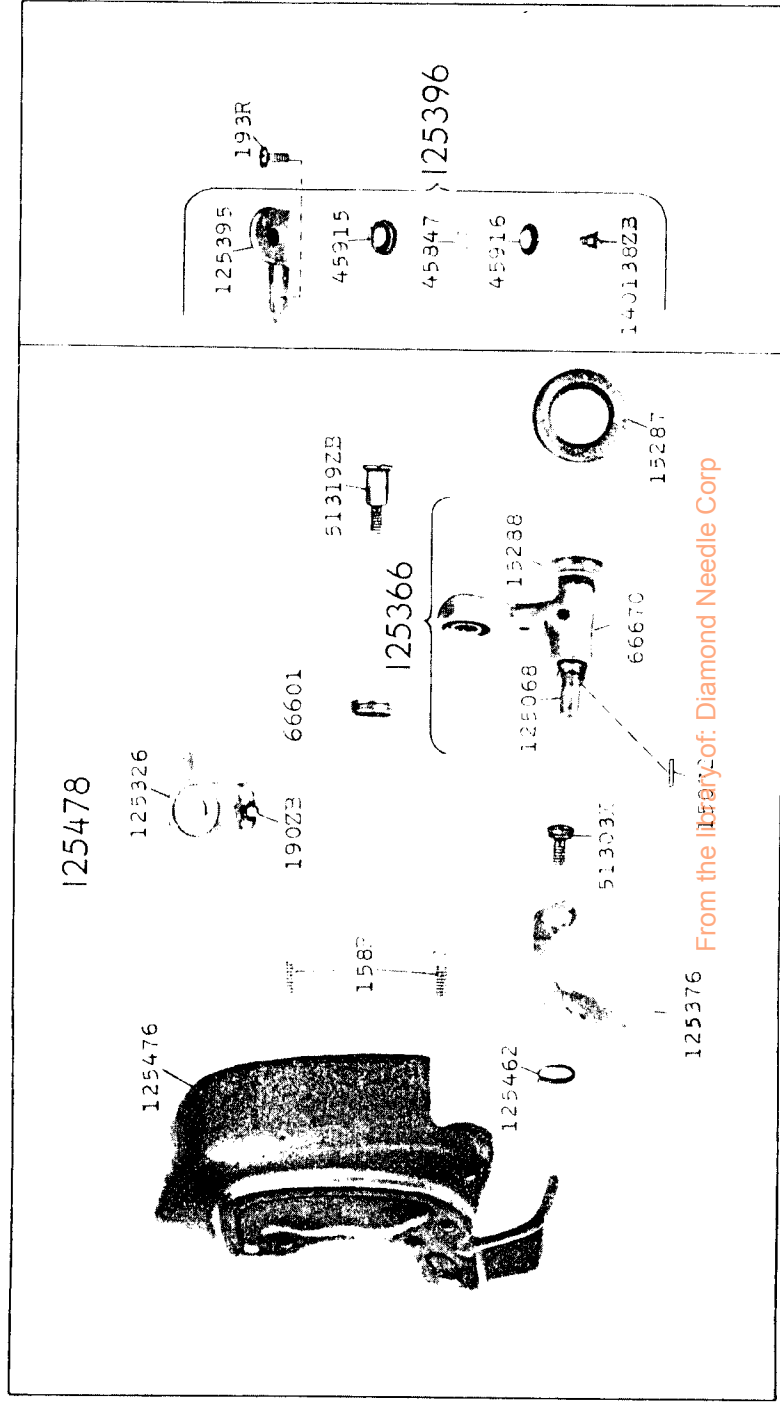
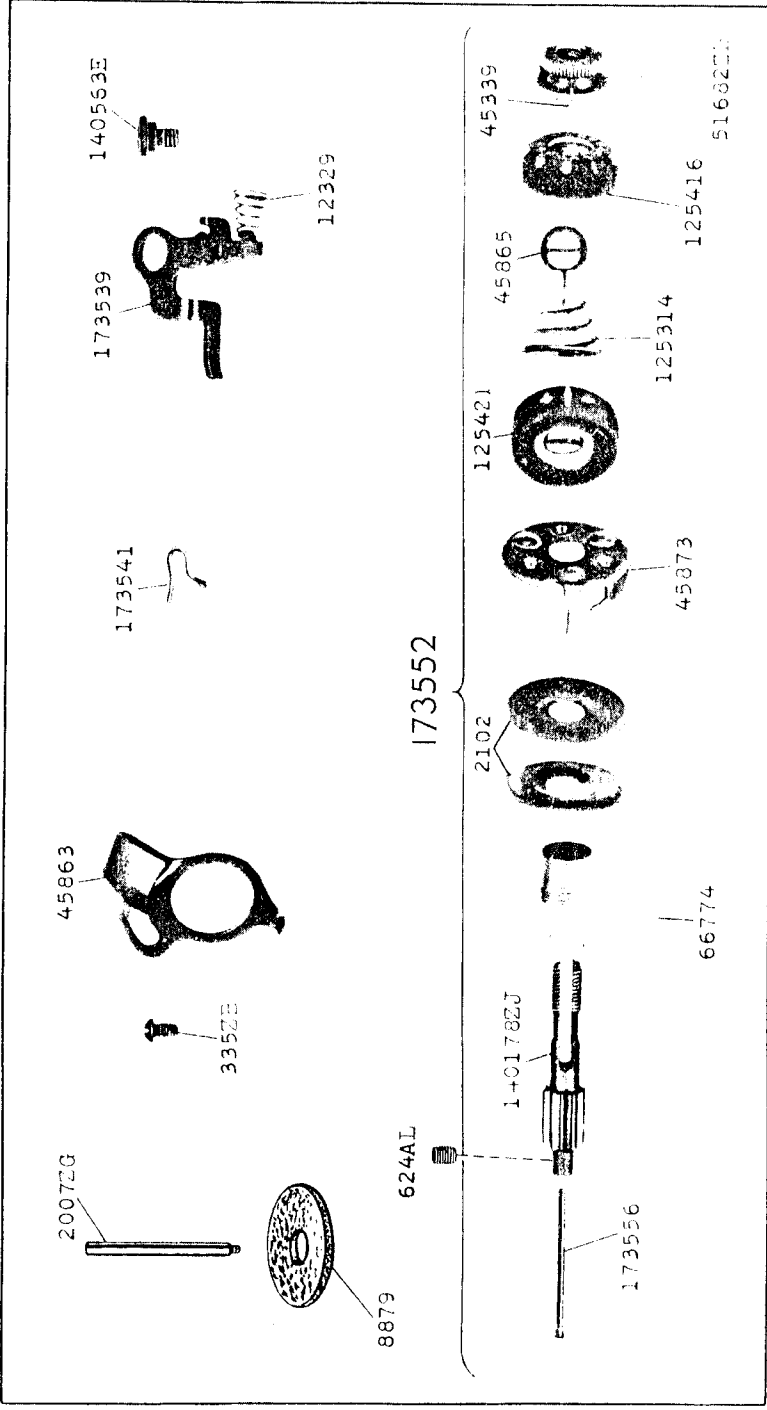

From the library of: Diamond Needle Corp

LIST OF PARTS  
FOR  
191K1 to 191K3 Machines

CONTENTS

	Page
Parts complete for 191K1 to 191K3 Machines	27
Attachments	35
Bobbin Winder	34
Embroidery Hoops	37
Hand Attachment	39
Numerical List of Parts	41

From the library of: Diamond Needle Corp

# INSTRUCTIONS FOR ORDERING

In ordering from this List the prefix and affix letters with the part number **MUST BE** quoted exactly as they are shown in the first column.

A number always indicates the same part in whatever List it may appear, or for whatever machine.

The affix letters and code numbers (where shown) indicate the style of finish, as follows:—

New Code	Old Code	
801	A.	Hardened, Polished, Nickel Plated and Buffed.
802	B.	Polished, Nickel Plated and Buffed.
803	C.	Hardened only.
804	D.	Polished only.
805	E.	Soft, Not Polished.
806	F.	Hardened and Polished.
807	G.	Bright Rumbled and Nickel Plated.
808	H.	Blued.
809	J.	Nickel Plated only.
810	K.	Hardened and Nickel Plated.
811	L.	Brass Plated.
812	M.	Oxidized.
813	R.	Phosphate Coating Formed on Surface of Iron or Steel.
814	S.	Cadmium Plated.
815	T.	Copper Plated.
816	U.	Zinc Plated.
817	V.	Silver Plated.
818	W.	Polished and Nickel Plated.
819	X.	Black Oxide for Iron and Steel.
820	Y.	Black Nickel Plated only.
821	Z.	Chromium Plated.
822	A.A.	Buffed and Chromium Plated.
823	A.B.	Hardened, Polished, Buffed and Chromium Plated.
824	A.E.	Hardened, Bright Rumbled and Nickel Plated.
825	A.F.	Hardened, Bright Rumbled, Nickel Plated, Bright Rumbled and Chromium Plated.
826	A.G.	Alumilite (Plain).
827	A.H.	Alumilite (Dyed). Colour must be stated.†
828	A.J.	Polished, Nickel Plated and Chromium Plated.
829	A.K.	Hardened, Polished, Nickel Plated and Chromium Plated.
830	A.L.	Heat Treated for Toughness.
831	A.L.D.	Heat Treated for Toughness and Polished.
832	A.L.J.	Heat Treated for Toughness and Nickel Plated.
833	A.L.X.	Heat Treated for Toughness and Black Oxide.
834	A.L.Z.B.	Heat Treated for Toughness, Polished, Nickel Plated, Buffed and Chromium Plated.
835	A.S.	Black Moulded Phenolic.
836	A.T.	Beige Moulded Phenolic.
837	A.U.	Brown Moulded Phenolic.
838		
839	B.A.	Chrome Nickel, Satin Finish.
840	B.B.	Hardened and Chrome Nickel, Satin Finish.
841	C.R.	Hardened and Phosphate Coating Formed on Surface of Steel.
842	C.U.	Hardened and Zinc Plated.
843	F.J.	Hardened, Polished and Nickel Plated.
844	T.A.	Hardened, Polished, Copper and Nickel Plated and Buffed.
845	T.B.	Copper and Nickel Plated and Polished.
846	T.J.	Copper and Nickel Plated only.
847	T.K.	Hardened, Copper and Nickel Plated.
848	T.L.	Copper and Brass Plated.
849	T.M.	Copper Plated and Oxidized.
850	X.C.	Hardened and Black Oxide for Iron and Steel.
851	Z.A.	Hardened, Polished, Nickel Plated, Buffed and Chromium Plated.
852	Z.B.	Polished, Nickel Plated, Buffed and Chromium Plated.
853	Z.C.	Hardened and Chromium Plated.
854	Z.D.	Polished and Chromium Plated.
855	Z.G.	Bright Rumbled, Nickel Plated, Bright Rumbled and Chromium Plated.
856	Z.J.	Nickel and Chromium Plated.
857	Z.T.	Copper and Chromium Plated.
858	A.L.Z.J.	Heat Treated for Toughness, Nickel and Chromium Plated.

Parts marked with an asterisk (\*) are furnished only when repairs are made at Factory.

# PARTS COMPLETE

FOR

## Nos. 191K1 to 191K3 MACHINES

Lock Stitch, C.B. Oscillating Shuttle, Reversible Feed, Link Take-up, Feed Throw-out Device for Darning and Embroidery for Family Use.

No.	Plate	
*173601		Arm ... ..
NOTE. Arm cannot be supplied separately and can only be sent as a unit, Arm and Bed assembled.		
†173501		Arm and Bed, with Nos. 81110, 125331, 125331 and four 1105431.
2002	2816	" Dowel Pin (2) ... ..
125331	2816	" Oil Pad (left) for oiling Arm Shaft Back Bearing
81110	2816	" " " Spring ... ..
125331	2816	" " " Cap ... ..
138c	2816	" Screw (3) ... ..
173603	2816	" Shaft ... ..
173559	-	" " 173603 with 171509, 171512, 173503 and 173600 ...
173503	2816	" " Bushing ... ..
435a1	2816	" " " Set Screw ... ..
171509	-	" " Counterbalance with 1285a1 ... ..
1285a1	2816	" " " Position Screw ... ..
†125466	26001	" Side Cover ... ..
51224zb	26001	" " " Thumb Screw ... ..
2007zg	26007	" Spool Pin ... ..
*173602		Bed ... ..
NOTE. Bed cannot be supplied separately and can only be sent as a unit, Arm and Bed assembled.		
256zb	2816	Clamp Stop Motion Clamp Screw ... ..
248za	2816	" " " " Stop Screw ... ..
171502	2816	" " " " Washer ... ..
*15312	-	" " " Flanged Bushing ... ..
15313	2816	" " " " 15312 with two 462a1 ...
2022	-	" " " " Pin ... ..
462a1	2816	" " " " Set Screw ... ..
15314	-	Clamp Stop Motion, complete, Nos. 248za, 256zb, 15313 and 171502 (for Agents only)

† In ordering it is necessary to state Colour of Machine.

From the library of: Diamond Needle Corp

No.	Plate				
125021	2816	<b>Crank Connecting Rod</b> with 125044 and two 896al	...	...	...
896al	2816	" " " Cap Screw	...	...	...
375c	2816	" " " Hinge Screw	...	...	...
1518r	2816	" " " " " Nut	...	...	...
125044	2816	" " " Oil Pad (felt)	...	...	...
173504zb	---	<b>Face Plate</b> for 173505zb	...	...	...
†173572	26002	" " " 173573	...	...	...
173505zb	---	<b>Face Plate</b> , complete, Nos. 173504zb, two each 32755 and 173616 for Black Machines	...	...	...
173573	26002	<b>Face Plate</b> , complete, Nos. 173572, two each 32755 and 173616 (for Two-Tone finish machines)	...	...	...
140991zb	26002	<b>Face Plate</b> Screw	...	...	...
32755	"	" " Thread Guard	...	...	...
173615	26002	" " " " 32755 with 173616 (for Agents only)	...	...	...
173616	"	" " " Rivet	...	...	...
51224zb	26002	" " Thumb Screw	...	...	...
173508	2818	<b>Feed Bar</b>	...	...	...
1904	2818	" " Roller	...	...	...
1813	"	" " " and Stud, Nos. 1904 and 125060	...	...	...
*125060	"	" " " Stud	...	...	...
315c	2818	" " Screw Centre	...	...	...
15445	"	" " " " 315c with 1519r (2)	...	...	...
1519r	2818	" " " " Nut	...	...	...
171512	2816	<b>Feed Cam</b> with 1285al	...	...	...
1285al	2816	" " Position Screw	...	...	...
15279	2817	<b>Feed Dog</b> , 12 teeth (14 teeth to the inch)	...	...	...
208al	2817	" " Screw (2)	...	...	...
125262	2816	<b>Feed Forked Connection</b> with 175r	...	...	...
125340	"	" " " 125262 with 125335	...	...	...
175r	2816	" " " Adjusting Screw	...	...	...
1381c	2816	" " " Hinge Screw (eccentric)	...	...	...
1520r	2816	" " " " " Nut	...	...	...
125047	2816	" " " Slide Block	...	...	...
125335	"	" " " " " 125047 with 1085c	...	...	...
1085c	2816	" " " " " Screw Stud	...	...	...
173510u	2818	<b>Feed Lifting Rock Shaft</b>	...	...	...
173511	---	" " " " with Feed Throw-out Assembly, complete, Nos. 173510u, 173513 and 173520x	...	...	...
173512	2818	<b>Feed Lifting Rock Shaft Crank</b> with 704x and 50150al	...	...	...
704x	2818	" " " " Clamping Screw	...	...	...

† In ordering it is necessary to state Colour of Machine.

No.	Plate				
173513	---	<b>Feed Lifting Rock Shaft Crank</b> with Feed Throw-out Lever, complete, Nos. 173512 and 173515 to 173517u	...	...	...
125048	2818	<b>Feed Lifting Rock Shaft Centre</b> (left)	...	...	...
125049	2818	" " " " (right)	...	...	...
51246al	2818	" " " " Set Screw (2)	...	...	...
125397	2816	<b>Feed Regulator</b>	...	...	...
125398	"	" " 125397 with 125381	...	...	...
50353c	2816	" " Hinge Screw	...	...	...
125399	2816	" " " " Friction Washer	...	...	...
45305	26001	<b>Feed Reversing Handle</b>	...	...	...
125381	"	" " " 45305 with 1550r	...	...	...
1550r	26001	" " " Lock Nut	...	...	...
125270u	2818	<b>Feed Rock Shaft</b>	...	...	...
125048	2818	" " " Centre (left)	...	...	...
125049	2818	" " " " (right)	...	...	...
51246al	2818	" " " " Set Screw (2)	...	...	...
†173514	2818	<b>Feed Throw-out Knob</b> with 442al	...	...	...
442al	2818	" " " Set Screw	...	...	...
173547	2818	" " " Shaft and Bobbin Winder Spool Pin	...	...	...
173515	2818	" " " Lever with 1813	...	...	...
173516	2818	" " " Tension Spring	...	...	...
173517u	2818	" " " " Hinge Stud	...	...	...
50150al	2818	" " " " Set Screw	...	...	...
173518u	2818	" " " Pitman Rod	...	...	...
21202j	2818	" " " " Washer (2)	...	...	...
140138j	2818	" " " " Screw (2)	...	...	...
173519x	2818	" " " Plunger	...	...	...
173520x	2818	" " " Bracket	...	...	...
†125473	2816	<b>Hand Wheel</b> , 2½" pulley, for 191K1 Machine	...	...	...
†173548	2816	" " (spoked), 2½" pulley, for 191K2 Machine	...	...	...
†32672	2816	" " (disc), 3½" pulley, for 191K3 Machine	...	...	...
120842	2821	<b>Hemmer (foot)</b> $\frac{3}{4}$ " hem (packed with accessories)	...	...	...
51045al	2816	<b>Machine Hinge Connection Set Screw</b> (2)	...	...	...
15271	---	<b>Needle</b> , size 14	...	...	...
173608	2819	<b>Needle Bar</b>	...	...	...
*125272	2819	" " Bushing	...	...	...
125273	"	" " " 125272 with 125274	...	...	...
125274	2819	" " " Oil Pad (felt)	...	...	...
1498al	2819	" " " Set Screw	...	...	...

† In ordering it is necessary to state Colour of Machine.

No.	Plate	
45231	2819	<b>Needle Bar</b> Connecting Link with 51002e ...
173524	---	" " " " 45231 with 173551 ...
51002e	2819	" " " " Adjusting Screw ...
1130e	2819	" " " " Cap Screw ...
173551	2819	" " " " Stud with 51363e ...
51363e	2819	" " " " Set Screw ...
173600	2816	" " " " Crank with 1036a1 and 1293a1 ...
1293a1	2816	" " " " Position Screw ...
173555	2819	" " " " Hole Plug ...
173609	2819	<b>Needle Clamp</b> ...
173610	2819	" " " " 173609 with 140545e ...
173611	2819	" " " " Gib ...
140876k	2819	" " " " Locating Screw ...
140545e	2819	" " " " Thumb Screw ...
140543L	---	<b>Number Plate Drive Screw</b> ...
125055u	2818	<b>Oscillating Rock Shaft</b> with 125056 ...
125048	2818	" " " " Centre (left) ...
51246a1	2818	" " " " " ( " ) Set Screw ...
125049	2818	" " " " " (right) ...
51246a1	2818	" " " " " ( " ) Set Screw ...
125056	2818	" " " " Oil Wick (braided cotton) ...
2510	2818	<b>Oscillating Shaft</b> ...
*125063	---	" " " " 2510 with 2049 and 125062 ...
*125086	---	" " " " 125063 with 125058u, 125065 and two 51229e ...
*125057u	---	" " " " Crank ...
*125058u	---	" " " " 125057u with 462a1 and 125330 ...
125059	2818	" " " " 125057u with 125330 and two 462a1 <i>(for Agents only)</i>
2049	---	" " " " Pin ...
462a1	2818	" " " " Set Screw ...
*15170	---	" " " " Slide Block ...
125330	2818	" " " " " " 15170 with 125060 ...
*125060	---	" " " " " " Stud ...
125061	2819	<b>Presser Bar</b> ...
173527	2819	" " " " Guide Bracket with 454a1 ...
454a1	2819	" " " " " " Set Screw ...
170066	2819	" " " " Lifter ...
85c	2819	" " " " " " Hinge Stud ...
80011	2819	" " " " Spring ...
2070	2819	" " " " " " Washer ...
45329	---	<b>Presser Foot</b> Hinge Pin ...
*45319	---	" " " " Plate ...
*32774	---	" " " " Shank ...
45321	2817	" " " " (hinged) complete, Nos. 32774, 45319 and 45329 ...
51224zb	2817	" " " " Thumb Screw ...

No.	Plate	
*140768zb	2819	<b>Pressure Regulating Thumb Screw</b> ...
173557	---	" " " " " " 140768zb with 66752 ...
66752	2819	" " " " " " Plug (felt) ...
2518	2820	<b>Shuttle Bobbin</b> (5), 1 in machine, 4 packed with accessories ...
15140	2820	" " " " Case Latch ...
2973	2820	" " " " " " Lever ...
2974	2820	" " " " " " Fulcrum Pin ...
2975	2820	" " " " " " Spring ...
592e	2820	" " " " " " Stop Screw ...
15141	2820	" " " " " " Hinge, Nos. 2973, 2974 and 15140 ...
15277	2820	" " " " " " Nos. 592e, 2975 and 15141 ...
2515	2820	" " " " " " Body ...
5911	2820	" " " " " " Tension Regulating Screw ...
15278	2820	" " " " " " Spring ...
125018	2820	<b>Shuttle</b> , 1 1/16" diam., complete, Nos. 2515, 2518 and 15277 ...
*125062	---	<b>Shuttle Driver</b> ...
125092	2818	" " " " 125062 with two 462a1 ...
125061	---	" " " " 125092 with 125065 and two 51229e <i>(for Agent only)</i>
125065	2818	" " " " Cushion Spring ...
51229e	2818	" " " " " " Screw ...
2049	---	" " " " Pin ...
462a1	2818	" " " " Set Screw ...
171539	2820	<b>Shuttle Race Body</b> ...
171540	---	" " " " " " 171539 with 171515 and two 662j <i>(for Agents only)</i>
171515	2820	" " " " " " Cap ...
662j	2820	" " " " " " Screw ...
171541	2820	<b>Shuttle Race</b> , complete, Nos. 171515, 171539, 171543 to 171546, 173551, two each 87k, 662j, 173536 and 173538 ...
171542	---	<b>Shuttle Race</b> , complete, Nos. 2515, 171515, 171539, 171543 to 171546, 173551, two each 87k, 662j, 173536 and 173538 <i>(for Agents only)</i>
171543	2820	<b>Shuttle Race Gate</b> ...
173551	2820	" " " " " " Hinge Pin ...
171541	2820	" " " " " " Stud ...
171545	2820	" " " " " " Nut ...
171546	2820	" " " " " " Spring ...
173536	2820	" " " " " " Latch ...
87k	2820	" " " " " " Screw ...
173538	2820	" " " " " " Spring ...
145j	2820	" " " " " " Screw (2) ...

No.	Plate						
125336	2817	<b>Shuttle Race Slide</b>	...	...	...	...	...
125337	2817	" " " Spring	...	...	...	...	...
51282zj	2817	" " " " Screw	...	...	...	...	...
125338	2817	<b>Shuttle Race Slide, complete, Nos. 125336, 125337 and two 51282zj</b>	...	...	...	...	...
45863	26007	<b>Slack Thread Regulator and Tension Thread Guide</b>	...	...	...	...	...
335zb	26007	" " " Screw	...	...	...	...	...
†125475	26001	<b>Stitch Indicator Plate</b>	...	...	...	...	...
335zb	26001	" " " Screw (2)	...	...	...	...	...
125481	26001	" Regulating Plate	...	...	...	...	...
125479	----	" " " 125481 with 45310, 51312zb, 125400 and 125475	...	...	...	...	...
51312zb	26001	" " Thumb Screw	...	...	...	...	...
125400	26001	" " " " Friction Washer	...	...	...	...	...
45310	26001	" " " " Washer (fibre)	...	...	...	...	...
2102	26007	<b>Tension Disc</b>	...	...	...	...	...
†125421	26007	" Indicator	...	...	...	...	...
†125416	26007	" " Flange	...	...	...	...	...
45865	26007	" " " Stop Washer	...	...	...	...	...
51682zb	26007	" Regulating Thumb Nut with 45339	...	...	...	...	...
45339	26007	" " " " Engaging Pin	...	...	...	...	...
173539	26007	" Releasing Lever...	...	...	...	...	...
140563e	26007	" " " Hinge Screw	...	...	...	...	...
12329	26007	" " " Spring	...	...	...	...	...
173556	26007	" " Pin	...	...	...	...	...
125314	26007	" Spring	...	...	...	...	...
140178zj	26007	" Stud	...	...	...	...	...
45352	-	" " 140178zj with 51682zb	...	...	...	...	...
624a1	26007	" " Set Screw	...	...	...	...	...
173552	26007	<b>Tension</b> (graduated), complete, Nos. 45352, 45865, 45873, 66774, 125314, 125416, 125421, 173556 and two 2102	...	...	...	...	...
26075	2819	<b>Thread Cutter and Holder</b>	...	...	...	...	...
173541	26007	" Guard (head of arm, upper)	...	...	...	...	...
173542	2819	<b>Thread Take-up Crank</b>	...	...	...	...	...
173566	-	" " " 173542 with 1130e and 173524	...	...	...	...	...
1036a1	2816	" " " Set Screw	...	...	...	...	...

† In ordering it is necessary to state Column of Machine.

No.	Plate						
45261	2819	<b>Thread Take-up Lever</b>	...	...	...	...	...
173563		" " " 45261 with 173545 and 173553	...	...	...	...	...
173564		" " " complete, Nos. 1130e, 173558 and 173563	...	...	...	...	...
173565		" " " 173564 with 173566	...	...	...	...	...
173553	2819	" " " Hinge Stud	...	...	...	...	...
173545	2819	" " " Link	...	...	...	...	...
173558	2819	" " " " Hinge Stud	...	...	...	...	...
1130e	2819	" " " " " " Cap Screw	...	...	...	...	...
440a1	2819	" " " " " " Set Screw	...	...	...	...	...
66774	26007	<b>Thread Take-up Spring</b>	...	...	...	...	...
45873	26007	" " " Thread Guard	...	...	...	...	...
125113	2817	<b>Throat Plate for 15279</b>	...	...	...	...	...
691za	2817	" " Screw (2)	...	...	...	...	...
140543L	-	<b>Trademark Drive Screw</b>	...	...	...	...	...

From the library of: Diamond Needle Corp

## Bobbin Winder

For HAND WHEELS Nos. 32672, 125473 and 173548

No.	Plate						
†125476	26009	<b>Bracket</b> (belt cover)	...	...	...	...	...
158j	26009	" Screw (2)	...	...	...	...	...
†66670	26009	<b>Frame</b>	...	...	...	...	...
125366	26009	" 66670 with 15288 and 125068	...	...	...	...	...
51319r	26009	" Hinge Screw	...	...	...	...	...
66601	26009	" Spring	...	...	...	...	...
†15287	26009	<b>Friction Ring</b> (rubber)	...	...	...	...	...
15288	26009	<b>Pulley</b>	...	...	...	...	...
125068	26009	<b>Spindle</b>	...	...	...	...	...
125376	26009	<b>Stop Latch</b>	...	...	...	...	...
51303x	26009	" " Hinge Screw	...	...	...	...	...
125462	26009	" " Spring	...	...	...	...	...
125395	26009	<b>Tension Bracket</b>	...	...	...	...	...
125396	26009	" " complete, Nos. 45847, 45915, 45916, 125395 and 140138zb	...	...	...	...	...
193zb	26009	" " Screw	...	...	...	...	...
45915	26009	" Disc	...	...	...	...	...
45916	26009	" " Screw Washer	...	...	...	...	...
45847	26009	" " Spring	...	...	...	...	...
140138zb	26009	" Screw	...	...	...	...	...
125326	26009	<b>Tripping Arm</b>	...	...	...	...	...
190r	26009	" " Screw	...	...	...	...	...
†125478	26009	<b>Bobbin Winder</b> (automatic), complete, Nos. 190r, 15287, 51303x, 51319r, 66601, 125326, 125366, 125376, 125462 and 125476	...	...	...	...	...

† In ordering it is necessary to state Colour of Machine.

## Attachments

### ATTACHMENT SET No. 161324

(Packed in Cardboard Box)

(For All Countries except Denmark, Norway, Sweden and Switzerland)

No.	Plate						
121464	2574	Binder	...	...	...	...	...
25527b	2719	Cloth Guide	...	...	...	...	...
50053b	2719	" " Thumb Screw	...	...	...	...	...
121441	2574	Gathering Foot (double toe)	...	...	...	...	...
161307	-	Needle Threader (wire)	...	...	...	...	...
15x1	-	Needles, three each sizes 11 and 14	...	...	...	...	...
161127	2719	Presser Foot (hinged, adjustable) for sewing on the right or left side of the needle, for Edge Stitching, Cording and Slide Fastener Work	...	...	...	...	...
86742	2574	Ruffler	...	...	...	...	...
161294	2574	Screw Driver (machine)	...	...	...	...	...
161295	2574	" " (bobbin case) (120378 will be supplied until stock is exhausted)	...	...	...	...	...
8879	2574	Spool Pin Washer (cloth)	...	...	...	...	...
120861	-	Tin of Oil (3 oz.)	...	...	...	...	...
161324	-	Attachment Set, complete, Nos. 25527b, 50053b, 86742, 120861, 121441, 121464, 161127, 161294, 161295, 161307, two 8879 and six needles 15x1 (three each sizes 11 and 14)	...	...	...	...	...

### ATTACHMENT SET No. 161325

(Packed in Cardboard Box)

(For Denmark, Norway, Sweden and Switzerland)

This is the same as Set No. 161324 with the following addition :

121094	2719	Darning Foot	...	...	...	...	...
161325	-	Attachment Set, complete, Nos. 25527b, 50053b, 86742, 120861, 121094, 121441, 121464, 161127, 161294, 161295, 161307, two 8879 and six needles 15x1 (three each sizes 11 and 14)	...	...	...	...	...



## Fashion Aids

Available for separate purchase

25525	2719	Bias Gauge	...	...	...	...	...	...
86649		Blind Stitch Attachment	...	...	...	...	...	...
86718		Buttonhole Attachment	...	...	...	...	...	...
121094	2719	Darning Foot (spring)	...	...	...	...	...	...
36865	2574	Edge Stitcher	...	...	...	...	...	...
85893	2821	Embroidery Foot (for art work)	...	...	...	...	...	...
36835	2821	Feller (foot)	...	...	...	...	...	...
86192		Gathering Foot (slotted)	...	...	...	...	...	...
35931	2574	Hemmer (adjustable)	...	...	...	...	...	...
120687	2821	Imitation Hemstitching Attachment with Yielding Presser Plate	...	...	...	...	...	...
160845	2719	Presser Foot (left toe) for Edge Stitching, Cording and Slide Fastener Work	...	...	...	...	...	...
160846	2719	Presser Foot (right toe) for Edge Stitching, Cording and Slide Fastener Work	...	...	...	...	...	...
35932	2719	Quilter	...	...	...	...	...	...
121170	909	Ruffler Shirring Plate	...	...	...	...	...	...
25539	2719	Stiletto	...	...	...	...	...	...
36583	2821	Tucker	...	...	...	...	...	...
121547	909	Under Braider	...	...	...	...	...	...

## Embroidery Hoops

(Plain)

(Birch)

No.	Plate	
101336		Hoop (inner) ... ..
101337		" (outer) ... ..
87586		" (round) 5 $\frac{5}{8}$ " diam. $\times$ 7 $\frac{m}{m}$ high, Nos. 101336 and 101337
101346		" (inner) ... ..
101347		" (outer) ... ..
96416		" (round) 7" diam. $\times$ 7 $\frac{m}{m}$ high, Nos. 101346 and 101347
101338		" (inner) ... ..
101339		" (outer) ... ..
87589	2659	" (round) 8" diam. $\times$ 7 $\frac{m}{m}$ high, Nos. 101338 and 101339
101340		" (inner) ... ..
101341		" (outer) ... ..
87593		" (round) 10" diam. $\times$ 7 $\frac{m}{m}$ high, Nos. 101340 and 101341
101342		" (inner) ... ..
101343		" (outer) ... ..
87595		" (round) 12" diam. $\times$ 7 $\frac{m}{m}$ high, Nos. 101342 and 101343
101358		" (inner) ... ..
101359		" (outer) ... ..
96422	2659	" (oval) 9" $\times$ 4 $\frac{1}{2}$ " $\times$ 7 $\frac{m}{m}$ high, Nos. 101358 and 101359
101344		" (inner) ... ..
101345		" (outer) ... ..
87597		" (oval) 12" $\times$ 5 $\frac{1}{2}$ " $\times$ 7 $\frac{m}{m}$ high, Nos. 101344 and 101345

From the library of: Diamond Needle Corp

## Embroidery Hoops

(With Spring)

(Birch)

No.	Plate	
101361		Hoop (inner) for 101246 ... ..
101365		" (outer) with Spring, for 101246 ... ..
101246		" (round) 10" diam. $\times$ 7 $\frac{m}{m}$ high, Nos. 101364 and 101365

## Embroidery Hoops

(With Clamp)

(Birch)

No.	Plate	
101348	---	Hoop (inner) ... ..
101349	---	" (outer) with SS528j, NN95j, two 96425 and four 96427 ...
96417	---	" (round) 5 $\frac{5}{8}$ " diam. $\times$ 7 $\frac{m}{m}$ high, Nos. 101348 and 101349 ...
101350	---	" (inner) ... ..
101351	---	" (outer) with SS528j, NN95j, two 96426 and four 96427 ...
96418	2659	" (round) 7" diam. $\times$ 7 $\frac{m}{m}$ high, Nos. 101350 and 101351 ...
101352	---	" (inner) ... ..
101353	---	" (outer) with SS528j, NN95j, two 96426 and four 96427 ...
96419	---	" (round) 8" diam. $\times$ 7 $\frac{m}{m}$ high, Nos. 101352 and 101353 ...
101354	---	" (inner) ... ..
101355	---	" (outer) with SS528j, NN95j, two 96426 and four 96427 ...
96420	---	" (round) 10" diam. $\times$ 7 $\frac{m}{m}$ high, Nos. 101354 and 101355 ...
101356	---	" (inner) ... ..
101357	---	" (outer) with SS528j, NN95j, two 96844 and four 96845 ...
96421	---	" (round) 12" diam. $\times$ $\frac{1}{2}$ " high, Nos. 101356 and 101357 ...
101360	---	" (inner) ... ..
101361	---	" (outer) with SS528j, NN95j, 96425, 96426 and four 96427 ...
96423	---	" (oval) 9" $\times$ 4 $\frac{1}{2}$ " $\times$ 7 $\frac{m}{m}$ high, Nos. 101360 and 101361 ...
101362	---	" (inner) ... ..
101363	---	" (outer) with SS528j, NN95j, 96425, 96426 and four 96427 ...
96424	---	" (oval) 12" $\times$ 5 $\frac{1}{2}$ " $\times$ 7 $\frac{m}{m}$ high, Nos. 101362 and 101363 ...
96425	2399	Clamping Bracket for 101349, 101361 and 101363 ...
96426	2399	" " " 101351, 101353, 101355, 101361 and 101363 ...
96844	2399	" " " 101357 ... ..
96427	2399	" " Rivet for 101349, 101351, 101353, 101355, 101361 and 101363 ...
96845	2399	" " Rivet for 101357 ... ..
SS528j	2399	" " Screw ... ..
NN95j	2399	" " " Nut ... ..

## Hand Attachment

No.	Plate	
†94050	2284	Body ... ..
†94027	2284	" Bracket ... ..
183e	2114	" " Screw ... ..
†94028	2114	Crank Handle ... ..
94029b	2114	" " Spindle ... ..
94069	2114	" Hinge Pin ... ..
94031za	2284	" Lever ... ..
94032	2114	" " Lock Pin ... ..
94033zb	2114	" " " " Head ... ..
55531	2114	" " " " Spring ... ..
94034b	---	Crank, complete, Nos. 94028, 94029b and 94031za ...
†94046	2114	Driver ... ..
94070	---	" 94046 with 80028 and 94048 ... ..
94036	2114	" Finger ... ..
94041	---	" " 94036 with SS567e, 94039 and 94040 ...
94039	2114	" " Driving Pad (raw-bide) ... ..
94040	2114	" " " " Plate ... ..
SS567e	2114	" " " " and Plate Binding Screw ... ..
94044	2114	" " Hinge Pin ... ..
94037	2114	" " Latch ... ..
SS565e	2114	" " " Screw Stud ... ..
94038	2114	" " " Spring ... ..
†94051	2284	Gear with 55531, 94032 and 94033zb ... ..
†94016	2284	" Cover ... ..
399za	2114	" " Screw ... ..
SS599f	2114	" " Screw Stud ... ..
94048	2114	Pinion ... ..
80028	2114	" Dowel Pin ... ..
SS600f	2114	" Screw Stud ... ..
†94052	2284	<b>Hand Attachment</b> , complete, Nos. SS565e, SS566e, SS599f, SS600f, 94016, 94027, 94034b, 94037, 94038, 94041, 94044, 94050, 94051, 94069, 94070, two each 183e and 399za ...
SS566e	2114	Hand Attachment Screw ... ..

† In ordering it is necessary to state Colour of Machine.

## Numerical List of Parts

No.	Plate	
85e	2819	Presser Bar Lifter Hinge Stud ... ..
87k	2820	Shuttle Race Gate Latch Screw for 171541 and 171542 ... ..
NN95j	2399	Embroidery Hoop Clamping Bracket Screw Nut for 101349, 101351, 101353, 101355, 101357, 101361 and 101363 ... ..
138e	2816	Arm Screw ... ..
145j	2820	Shuttle Race Screw ... ..
158j	26009	Bobbin Winder Bracket Screw ... ..
175r	2816	Feed Forked Connection Adjusting Screw for 125262 ... ..
183e	2114	Hand Attachment Body Bracket Screw for 94052 ... ..
190r	26009	Bobbin Winder Tripping Arm Screw for 125478 ... ..
193zb	26009	Bobbin Winder Tension Bracket Screw ... ..
208al	2817	Feed Dog Screw ... ..
248za	2816	Clamp Stop Motion Clamp Stop Screw for 15314 ... ..
256zb	2816	Clamp Stop Motion Clamp Screw for 15314 ... ..
315c	2818	Feed Bar Screw Centre for 15445 ... ..
335zb	26007	Slack Thread Regulator Screw ... ..
335zb	26001	Stitch Indicator Plate Screw ... ..
375c	2816	Crank Connecting Rod Hinge Screw ... ..
399za	2114	Hand Attachment Gear Cover Screw for 94052 ... ..
435al	2816	Arm Shaft Bushing Set Screw ... ..
440al	2819	Thread Take-up Lever Link Hinge Stud Set Screw ... ..
442al	2818	Feed Throw-out Knob Set Screw for 173514 ... ..
454al	2819	Presser Bar Guide Bracket Set Screw for 173527 ... ..
462al	2816	Clamp Stop Motion Flanged Bushing Set Screw for 15313 ... ..
462al	2818	Oscillating Shaft Crank Set Screw for 125058u and 125059 ... ..
462al	2818	Shuttle Driver Set Screw for 125692 ... ..
SS528j	2399	Embroidery Hoop Clamping Bracket Screw for 101349, 101351, 101353, 101355, 101357, 101361 and 101363 ... ..
SS565e	2114	Hand Attachment Driver Finger Latch Screw Stud for 94052 ... ..

No.	Plate	
SS566c	2114	Hand Attachment Screw for 94052 ...
SS567c	2114	Hand Attachment Driver Finger Driving Pad and Plate Binding Screw for 94041 ...
591f	2820	Shuttle Tension Regulating Screw ...
592e	2820	Shuttle Bobbin Case Latch Stop Screw for 15277 ...
SS599f	2114	Hand Attachment Gear Screw Stud for 94052 ...
SS600f	2114	Hand Attachment Pinion Screw Stud for 94052 ...
624al	26007	Tension Stud Set Screw ...
662j	2820	Shuttle Race Cap Screw for 171540 to 171542
691za	2817	Throat Plate Screw ...
704x	2818	Feed Lifting Rock Shaft Crank Clamping Screw for 173512 ...
896al	2816	Crank Connecting Rod Cap Screw for 125021
1036al	2816	Thread Take-up Crank Set Screw for 173600
1085c	2816	Feed Forked Connection Slide Block Screw Stud for 125335 ...
1130e	2819	Needle Bar Connecting Link Cap Screw for 173564 ...
1130e	2819	Thread Take-up Lever Link Hinge Stud Cap Screw for 173566 ...
1285al	2816	Arm Shaft Counterbalance Position Screw for 171509 ...
1285al	2816	Feed Cam Position Screw for 171512 ...
1293al	2816	Needle Bar Crank Position Screw for 173600
1381c	2816	Feed Forked Connection Hinge Screw (eccentric)
1498al	2819	Needle Bar Bushing Set Screw ...
1518r	2816	Crank Connecting Rod Hinge Screw Nut ...
1519r	2818	Feed Bar Screw Centre Nut for 15445 ...
1520r	2816	Feed Forked Connection Hinge Screw Nut
1550r	26001	Feed Reversing Handle Lock Nut for 125381
1813	-	Feed Bar Roller and Stud, Nos. 1904 and 125060 for 173515 ...
1904	2818	Feed Bar Roller for 1813 ...
2002	2816	Arm Dowel Pin ...
2007zg	26007	Arm Spool Pin ...
2022	-	Clamp Stop Motion Flanged Bushing Pin ...
2049	-	Oscillating Shaft Crank Pin for 125063 ...
2049	-	Shuttle Driver Pin ...
2070	2819	Presser Bar Spring Washer ...
2102	26007	Tension Disc for 173552 ...
2510	2818	Oscillating Shaft for 125063 ...
2515	2820	Shuttle Body for 125018 and 171542 ...
2518	2820	Shuttle Bobbin for 125018 (5) (1 in machine, 4 packed with accessories) ...

No.	Plate	
2973	2820	Shuttle Bobbin Case Latch Lever for 15141
2974	2820	Shuttle Bobbin Case Latch Lever Fulcrum Pin for 15141 ...
2975	2820	Shuttle Bobbin Case Latch Spring for 15277
8879	2574	Spool Pin Washer (cloth) for 161324 and 161325 ...
12329	26007	Tension Releasing Lever Spring ...
15140	2820	Shuttle Bobbin Case Latch for 15141 ...
15141	2820	Shuttle Bobbin Case Hinge, Nos. 2973, 2974 and 15140 for 15277 ...
*15170	-	Oscillating Shaft Crank Slide Block for 125330 ...
15277	2820	Shuttle Bobbin Case, Nos. 592e, 2975 and 15141 for 125018 ...
15278	2820	Shuttle Tension Spring ...
15279	2817	Feed Dog, 12 teeth (14 teeth to 1/4 inch) ...
†15287	26009	Bobbin Winder Friction Ring (rubber) for 125478 ...
15288	26009	Bobbin Winder Pulley for 125366 ...
*15312	-	Clamp Stop Motion Flanged Bushing for 15313 ...
15313	2816	Clamp Stop Motion Flanged Bushing 15312, with two 462al, for 15314 ...
15314	-	Clamp Stop Motion, complete, Nos. 248za, 256zb, 15313 and 171502 (for Agents only)
15415	-	Feed Bar Screw Centre 315c with 15419r ...
21202j	2818	Feed Throw out Pitman Rod Washer ...
25525	2719	Bias Gauge ...
25527b	2719	Cloth Guide for 161324 and 161325 ...
25539	2719	Stiletto ...
26075	2819	Thread Cutter and Holder ...
†32672	2816	Hand Wheel (disc), 3 1/4" pulley, for 191K3 Machine ...
32755	-	Face Plate Thread Guard for 173505zb, 173573 and 173615 ...
*32774	-	Presser Foot Shank for 45321 ...
35931	2574	Hemmer (adjustable) ...
35932	2719	Quilter ...
36583	2821	Tucker ...
36835	2821	Feller (foot) ...
36865	2574	Edge Stitcher ...

† In ordering it is necessary to state Colour of Machine.

From the Archives of Diamond Needle Corp.

No.	Plate	
45231	2819	Needle Bar Connecting Link with 51002e, for 173524 ... ..
45261	2819	Thread Take-up Lever for 173563 ... ..
45305	26001	Feed Reversing Handle for 125381 ... ..
45310	26601	Stitch Regulating Thumb Screw Washer (fibre) for 125479 ... ..
*45319	---	Presser Foot Plate for 45321 ... ..
45321	2817	Presser Foot (binged) complete, Nos. 32774, 45319 and 45329 ... ..
45329	---	Presser Foot Hinge Pin for 45321 ... ..
45339	26007	Tension Regulating Thumb Nut Engaging Pin for 51682zb ... ..
45352	---	Tension Stud 140178zj with 51682zb for 173552 ... ..
45847	26009	Bobbin Winder Tension Disc Spring for 125396 ... ..
45863	26007	Slack Thread Regulator and Tension Thread Guide ... ..
45865	26007	Tension Indicator Flange Stop Washer for 173552 ... ..
45873	26007	Thread Take-up Spring Thread Guard for 173552 ... ..
45915	26009	Bobbin Winder Tension Disc for 125396 ... ..
45916	26009	Bobbin Winder Tension Disc Screw Washer for 125396 ... ..
50053b	2719	Cloth Guide and Under Braider Thumb Screw for 161324 and 161325 ... ..
50150al	2818	Feed Throw-out Lever Tension Spring Hinge Stud Set Screw for 173512 ... ..
50353e	2816	Feed Regulator Hinge Screw ... ..
51002e	2819	Needle Bar Connecting Link Adjusting Screw for 45231 ... ..
51045al	2816	Machine Hinge Connection Set Screw ... ..
51224zb	26001	Arm Side Cover Thumb Screw ... ..
51224zb	26002	Face Plate Thumb Screw ... ..
51224zb	2817	Presser Foot Thumb Screw ... ..
51229e	2818	Shuttle Driver Cushion Spring Screw for 125064 and 125086 ... ..
51246al	2818	Feed Lifting Rock Shaft Centre Set Screw ... ..
51246al	2818	Feed Rock Shaft Centre Set Screw ... ..
51246al	2818	Oscillating Rock Shaft Centre (left) Set Screw ... ..
51246al	2818	Oscillating Rock Shaft Centre (right) Set Screw ... ..
51282zj	2817	Shuttle Race Slide Spring Screw for 125338 ... ..
51303x	26009	Bobbin Winder Stop Latch Hinge Screw for 125478 ... ..

No.	Plate	
51312zb	26001	Stitch Regulating Thumb Screw for 125479 ... ..
51319r	26009	Bobbin Winder Frame Hinge Screw for 125478 ... ..
51363e	2819	Needle Bar Connecting Stud Set Screw for 173554 ... ..
51682zb	26007	Tension Regulating Thumb Nut with 45339 for 45352 ... ..
55531	2114	Hand Attachment Crank Lever Lock Pin Spring for 94051 ... ..
66601	26009	Bobbin Winder Frame Spring for 125478 ... ..
†66670	26009	Bobbin Winder Frame for 125366 ... ..
66752	2819	Pressure Regulating Thumb Screw Plug (felt) for 173557 ... ..
66774	26007	Thread Take-up Spring for 173552 ... ..
80041	2819	Presser Bar Spring ... ..
80028	2114	Hand Attachment Pinion Dowel Pin for 94070 ... ..
81110	2816	Arm Oil Pad Spring for 173501 ... ..
85893	2821	Embroidery Foot (for art work) ... ..
86192	---	Gathering Foot (slotted) ... ..
86649	---	Blind Stitch Attachment ... ..
86718	---	Buttonhole Attachment ... ..
86742	2574	Ruttler for 161324 and 161325 ... ..
87586	---	Embroidery Hoop (round, birch) 5 <sup>5</sup> / <sub>16</sub> " diam. × 7 <sup>m</sup> / <sub>16</sub> " high, Nos. 101336 and 101337 ... ..
87589	2659	Embroidery Hoop (round, birch) 8 <sup>7</sup> / <sub>16</sub> " diam. × 7 <sup>m</sup> / <sub>16</sub> " high, Nos. 101338 and 101339 ... ..
87593	---	Embroidery Hoop (round, birch) 10 <sup>1</sup> / <sub>16</sub> " diam. × 7 <sup>m</sup> / <sub>16</sub> " high, Nos. 101340 and 101341 ... ..
87595	---	Embroidery Hoop (round, birch) 12 <sup>1</sup> / <sub>16</sub> " diam. × 1 <sup>1</sup> / <sub>2</sub> " high, Nos. 101342 and 101343 ... ..
87597	---	Embroidery Hoop (oval, birch) 12" × 5 <sup>1</sup> / <sub>2</sub> " × 7 <sup>m</sup> / <sub>16</sub> " high, Nos. 101344 and 101345 ... ..
†94016	2284	Hand Attachment Gear Cover for 94052 ... ..
†94027	2284	Hand Attachment Body Bracket for 94052 ... ..
†94028	2114	Hand Attachment Crank Handle for 94034b ... ..
94029b	2114	Hand Attachment Crank Handle Spindle for 94034b ... ..
94031za	2284	Hand Attachment Crank Lever for 94034b ... ..
94032	2114	Hand Attachment Crank Lever Lock Pin for 94051 ... ..
94033zb	2114	Hand Attachment Crank Lever Lock Pin Head for 94051 ... ..
94034b	---	Hand Attachment Crank, complete, Nos. 94028, 94029b and 94031za for 94052 ... ..

† In ordering it is necessary to state Colour of Machine.

No.	Plate	
94036	2114	Hand Attachment Driver Finger for 94041
94037	2114	Hand Attachment Driver Finger Latch for 94052 ... ..
94038	2114	Hand Attachment Driver Finger Latch Spring for 94052 ... ..
94039	2114	Hand Attachment Driver Finger Driving Pad (raw-hide) for 94041 ... ..
94040	2114	Hand Attachment Driver Finger Driving Pad Plate for 94041 ... ..
94041	—	Hand Attachment Driver Finger 94036, with SS567e, 94039 and 94040, for 94052 ...
94044	2114	Hand Attachment Driver Finger Hinge Pin for 94052 ... ..
†94046	2114	Hand Attachment Driver for 94070 ...
94048	2114	Hand Attachment Pinion for 94070 ...
†94050	2284	Hand Attachment Body for 94052 ...
†94051	2284	Hand Attachment Gear with 55531, 94032 and 94033zb, for 94052 ... ..
†94052	2284	Hand Attachment, complete, Nos. SS565e, SS566e, SS599f, SS600f, 94016, 94027, 94034b, 94037, 94038, 94041, 94044, 94050, 94051, 94069, 94070, two each 183e and 399za ... ..
94069	2114	Hand Attachment Crank Hinge Pin for 94052 ... ..
94070	—	Hand Attachment Driver 94016 with 80028 and 94048, for 94052 ... ..
96416	—	Embroidery Hoop (round, birch) 7" diam. × 7 <sup>m</sup> / <sub>m</sub> high, Nos. 101346 and 101347 ...
96417	—	Embroidery Hoop (round, birch) 5½" diam. × 7 <sup>m</sup> / <sub>m</sub> high, Nos. 101348 and 101349 ...
96418	2659	Embroidery Hoop (round, birch) 7" diam. × 7 <sup>m</sup> / <sub>m</sub> high, Nos. 101350 and 101351 ...
96419	—	Embroidery Hoop (round, birch) 8" diam. × 7 <sup>m</sup> / <sub>m</sub> high, Nos. 101352 and 101353 ...
96420	—	Embroidery Hoop (round, birch) 10" diam. × 7 <sup>m</sup> / <sub>m</sub> high, Nos. 101354 and 101355 ...
96421	—	Embroidery Hoop (round, birch) 12" diam. × 7 <sup>m</sup> / <sub>m</sub> high, Nos. 101356 and 101357 ...
96422	2659	Embroidery Hoop (oval, birch) 9" × 4½" × 7 <sup>m</sup> / <sub>m</sub> high, Nos. 101358 and 101359 ...
96423	—	Embroidery Hoop (oval, birch) 9" × 4½" × 7 <sup>m</sup> / <sub>m</sub> high, Nos. 101360 and 101361 ...
96424	—	Embroidery Hoop (oval, birch) 12" × 5½" × 7 <sup>m</sup> / <sub>m</sub> high, Nos. 101362 and 101363 ...

† In ordering it is necessary to state Colour of Machine.

No.	Plate	
96425	2399	Embroidery Hoop Clamping Bracket for 101349, 101361 and 101363 ... ..
96426	2399	Embroidery Hoop Clamping Bracket for 101351, 101353, 101355, 101361 and 101363 ... ..
96427	2399	Embroidery Hoop Clamping Bracket Rivet for 101349, 101351, 101353, 101355, 101361 and 101363 ... ..
96844	2399	Embroidery Hoop Clamping Bracket for 101357 ... ..
96845	2399	Embroidery Hoop Clamping Bracket Rivet for 101357 ... ..
101246	—	Embroidery Hoop (round, birch) 10" diam. × 7 <sup>m</sup> / <sub>m</sub> high, complete, Nos. 101364 and 101365 ... ..
101336	—	Embroidery Hoop (inner) for 87586 ...
101337	—	Embroidery Hoop (outer) for 87586 ...
101338	—	Embroidery Hoop (inner) for 87589 ...
101339	—	Embroidery Hoop (outer) for 87589 ...
101340	—	Embroidery Hoop (inner) for 87593 ...
101341	—	Embroidery Hoop (outer) for 87593 ...
101342	—	Embroidery Hoop (inner) for 87595 ...
101343	—	Embroidery Hoop (outer) for 87595 ...
101344	—	Embroidery Hoop (inner) for 87597 ...
101345	—	Embroidery Hoop (outer) for 87597 ...
101346	—	Embroidery Hoop (inner) for 96416 ...
101347	—	Embroidery Hoop (outer) for 96416 ...
101348	—	Embroidery Hoop (inner) for 96417 ...
101349	—	Embroidery Hoop (outer) with SS528j, NN95j, two 96425 and four 96427, for 96417 ... ..
101350	—	Embroidery Hoop (inner) for 96418 ...
101351	—	Embroidery Hoop (outer) with SS528j, NN95j, two 96426 and four 96427, for 96418 ... ..
101352	—	Embroidery Hoop (inner) for 96419 ...
101353	—	Embroidery Hoop (outer) with SS528j, NN95j, two 96426 and four 96427, for 96419 ... ..
101354	—	Embroidery Hoop (inner) for 96420 ...
101355	—	Embroidery Hoop (outer) with SS528j, NN95j, two 96426 and four 96427, for 96420 ... ..
101356	—	Embroidery Hoop (inner) for 96421 ...
101357	—	Embroidery Hoop (outer) with SS528j, NN95j, two 96844 and four 96845, for 96421 ... ..

No.	Plate		
101358	—	Embroidery Hoop (inner) for 96422	...
101359	—	Embroidery Hoop (outer) for 96422	...
101360	---	Embroidery Hoop (inner) for 96423	...
101361	---	Embroidery Hoop (outer) with SS528j, NN95j, 96425, 96426 and four 96427 for 96423	... ... ...
101362	--	Embroidery Hoop (inner) for 96424	...
101363	--	Embroidery Hoop (outer) with SS528j, NN95j, 96425, 96426 and four 96427, for 96424	... ... ... ...
101364	--	Embroidery Hoop (inner) for 101246	...
101365	---	Embroidery Hoop (outer) with Spring, for 101246	... ... ...
120687	2821	Imitation Hemstitching Attachment, with yielding presser plate	... ...
120842	2821	Hemmer (foot), $\frac{5}{8}$ " hem (packed with accessories)	... ... ...
120861	-	Tin of Oil (3 oz.) for 161324 and 161325	...
121094	2719	Darning Foot (spring) for 161325	...
121170	909	Ruffler Shirring Plate	... ... ...
121441	2574	Gathering Foot (double toe) for 161324 and 161325	... ... ... ...
121464	2574	Binder for 161324 and 161325	... ...
121547	909	Under Braider	... ... ...
125018	2820	Shuttle, $1\frac{1}{8}$ " diam., complete, Nos. 2515, 2518 and 15277	... ... ... ...
125021	2816	Crank Connecting Rod with 125044 and two 896al	... ... ... ...
125044	2816	Crank Connecting Rod Oil Pad (felt) for 125021	... ... ... ...
125047	2816	Feed Forked Connection Slide Block for 125335	... ... ... ...
125048	2818	Feed Lifting Rock Shaft Centre (left)	...
125048	2818	Feed Rock Shaft Centre (left)	... ...
125048	2818	Oscillating Rock Shaft Centre (left)	...
125049	2818	Feed Lifting Rock Shaft Centre (right)	...
125049	2818	Feed Rock Shaft Centre (right)	... ...
125049	2818	Oscillating Rock Shaft Centre (right)	...
125055u	2818	Oscillating Rock Shaft with 125056	...
125056	2818	Oscillating Rock Shaft Oil Wick (braided cotton) for 125055u	... ... ... ...
*125057u	---	Oscillating Shaft Crank for 125058u and 125059	... ... ... ...
*125058u	---	Oscillating Shaft Crank 125057u with 462al and 125330 for 125086	... ... ... ...

No.	Plate		
125059	2818	Oscillating Shaft Crank 125057u with 125330 and two 462al (for Agents only)	... ...
*125060	-	Feed Bar Roller Stud for 1813	... ...
*125060	-	Oscillating Shaft Crank Slide Block Stud for 125330	... ... ... ...
125061	2819	Presser Bar	... ... ... ...
*125062	---	Shuttle Driver for 125063 and 125092	...
*125063	---	Oscillating Shaft 2510 with 2049 and 125062 for 125086	... ... ... ...
125064	---	Shuttle Driver 125092 with 125065 and two 51229e (for Agents only)	... ... ... ...
125065	2818	Shuttle Driver Cushion Spring for 125064 and 125086	... ... ... ...
125068	26009	Bobbin Winder Spindle for 125366	...
*125086	---	Oscillating Shaft 125063 with 125058u, 125065 and two 51229e	... ... ... ...
125092	2818	Shuttle Driver 125062, with two 462al for 125064	... ... ... ...
125113	2817	Throat Plate for 15279	...
125262	2816	Feed Forked Connection with 17501 for 125340	...
125270u	2818	Feed Rock Shaft	... ... ...
*125272	2819	Needle Bar Bushing for 125273	...
125273	-	Needle Bar Bushing 125272 with 125274	... ...
125274	2819	Needle Bar Bushing Oil Pad (felt) for 125273	...
125314	26007	Tension Spring for 173552	...
125326	26009	Bobbin Winder Tripping Arm for 125478	...
125330	2818	Oscillating Shaft Crank Slide Block 15170, with 125060, for 125058u and 125059	... ... ... ...
125331	2816	Arm Oil Pad (felt) for oiling Arm Shaft Back Bearing for 173501	... ... ... ...
125334	2816	Arm Oil Pad Spring Cap for 173501	...
125335	-	Feed Forked Connection Slide Block 125047, with 1085e, for 125340	... ... ... ...
125336	2817	Shuttle Race Slide for 125338	... ...
125337	2817	Shuttle Race Slide Spring for 125338	...
125338	2817	Shuttle Race Slide, complete, Nos. 125336, 125337 and two 51282zj	... ... ... ...
125340	---	Feed Forked Connection 125262 with 125335	...
125366	26009	Bobbin Winder Frame 66670 with 15288 and 125068 for 125478	... ... ... ...
125376	26009	Bobbin Winder Stop Latch for 125478	...
125381	---	Feed Reversing Handle 45305 with 1550r for 125398	... ... ... ...
125395	26009	Bobbin Winder Tension Bracket for 125396	...

No.	Plate	
125396	26009	Bobbin Winder Tension Bracket, complete, Nos. 45847, 45915, 45916, 125395 and 140138zb ... ..
125397	2816	Feed Regulator for 125398 ... ..
125398	—	Feed Regulator 125397 with 125381 ... ..
125399	2816	Feed Regulator Hinge Screw Friction Washer
125400	26001	Stitch Regulating Thumb Screw Friction Washer for 125479 ... ..
†125416	26007	Tension Indicator Flange, for 173552 ... ..
†125421	26007	Tension Indicator for 173552 ... ..
125462	26009	Bobbin Winder Stop Latch Spring for 125478
†125466	26001	Arm Side Cover ... ..
†125473	2816	Hand Wheel, 2½" pulley, for 191K1 Machine
†125475	26001	Stitch Indicator Plate for 125479 ... ..
†125476	26009	Bobbin Winder Bracket (belt cover) for 125478 ... ..
†125478	26009	Bobbin Winder (automatic), complete, Nos. 190r, 15287, 51303x, 51319r, 66601, 125326, 125366, 125376, 125462 and 125476 for Hand Wheels Nos. 32672, 125473 and 173548 ... ..
125479	-	Stitch Regulating Plate 125381 with 45310, 51312zb, 125400 and 125475 ... ..
125481	26001	Stitch Regulating Plate for 125479 ... ..

† In ordering it is necessary to state Colour of Machine.

No.	Plate	
140138j	2818	Feed Throw-out Pitman Rod Washer Screw
140138zb	26009	Bobbin Winder Tension Screw for 125396 ... ..
140178zj	26007	Tension Stud for 45352 ... ..
140543L	-	Number Plate Drive Screw for 173501 ... ..
140543L	---	Trademark Drive Screw for 173501 ... ..
140545c	2819	Needle Clamp Thumb Screw for 173610 ... ..
140563e	26007	Tension Releasing Lever Hinge Screw ... ..
*140768zb	2819	Pressure Regulating Thumb Screw for 173557
140876k	2819	Needle Clamp Gib Locating Screw ... ..
140991zb	26002	Face Plate Screw ... ..
160845	2719	Presser Foot (left toe) for Edge Stitching, Cording and Slide Fastener Work ... ..
160846	2719	Presser Foot (right toe) for Edge Stitching, Cording and Slide Fastener Work ... ..
161127	2719	Presser Foot (hinged, adjustable) for sewing on the right or left side of the needle, for Edge Stitching, Cording and Slide Fastener Work, for 161324 and 161325 ... ..
161294	2574	Screw Driver (machine) for 161324 and 161325 ... ..
161295	2574	Screw Driver (bobbin case) for 161324 and 161325 ... ..
161307	-	Needle Threader (wire) for 161324 and 161325
161324	-	Attachment Set (packed in cardboard box) complete, Nos. 25527b, 50053b, 86742, 120861, 121441, 121464, 161127, 161294, 161295, 161307, two 8879 and six needles 15 × 1 (three each sizes 11 and 14) for All Countries except Denmark, Norway, Sweden and Switzerland ... ..
161325	-	Attachment Set (packed in cardboard box) complete, Nos. 25527b, 50053b, 86742, 120861, 121094, 121441, 121464, 161127, 161294, 161295, 161307, two 8879 and six needles 15 × 1 (three each sizes 11 and 14) for Denmark, Norway, Sweden and Switzerland ... ..



No.	Plate	
170066	2819	Presser Bar Lifter ... ..
171502	2816	Clamp Stop Motion Clamp Washer for 15314
171509	---	Arm Shaft Counterbalance with 1285al for 173559 ... ..
171512	2816	Feed Cam with 1285al for 173559 ... ..
171515	2820	Shuttle Race Cap for 171540 to 171542 ...
171539	2820	Shuttle Race Body for 171540 to 171542 ...
171540	---	Shuttle Race Body 171539 with 171515 and two 662j (for Agents only) ... ..
171541	2820	Shuttle Race, complete, Nos. 171515, 171539, 171543 to 171546, 173551, two each 87k, 662j, 173536 and 173538 ... ..
171542	---	Shuttle Race, complete, Nos. 2515, 171515, 171539, 171543 to 171546, 173551, two each 87k, 662j, 173536 and 173538 (for Agents only) ... ..
171543	2820	Shuttle Race Gate for 171541 and 171542 ...
171544	2820	Shuttle Race Gate Hinge Stud for 171541 and 171542 ... ..
171545	2820	Shuttle Race Gate Hinge Stud Nut for 171541 and 171542 ... ..
171546	2820	Shuttle Race Gate Hinge Stud Spring for 171541 and 171542 ... ..
†173501	-	Arm and Bed, with Nos. 81110, 125331, 125334 and four 140543L ... ..
173503	2816	Arm Shaft Bushing for 173559 ... ..
173504zb	---	Face Plate for 173505zb ... ..
173505zb	---	Face Plate, complete, Nos. 173504zb, two each 32755 and 173616 for Black Machines
173508	2818	Feed Bar ... ..
173510u	2818	Feed Lifting Rock Shaft for 173511 ... ..
173511	---	Feed Lifting Rock Shaft with Feed Throw-out Assembly, complete, Nos. 173510u, 173513 and 173520s ... ..
173512	2818	Feed Lifting Rock Shaft Crank, with 704x and 50150al for 173513 ... ..
173513	---	Feed Lifting Rock Shaft Crank with Feed Throw-out Lever, complete, Nos. 173512 and 173515 to 173517u for 173511 ... ..
†173514	2818	Feed Throw-out Knob with 442al ... ..
173515	2818	Feed Throw-out Lever with 1813 for 173513
173516	2818	Feed Throw-out Lever Tension Spring for 173513 ... ..
173517u	2818	Feed Throw-out Lever Tension Spring Hinge Stud for 173513 ... ..

† In ordering it is necessary to state Colour of Machine.

N	Plate	
173518u	2818	Feed Throw-out Pitman Rod ... ..
173519x	2818	Feed Throw-out Plunger ... ..
173520x	2818	Feed Throw-out Plunger Bracket for 173511
173524	---	Needle Bar Connecting Link 45231 with 173554 for 173566 ... ..
173527	2819	Presser Bar Guide Bracket with 454al ... ..
173536	2820	Shuttle Race Gate Latch for 171541 and 171542 ... ..
173538	2820	Shuttle Race Gate Latch Spring for 171541 and 171542 ... ..
173539	26007	Tension Releasing Lever... ..
173541	26007	Thread Guard (head of arm, upper) ... ..
173542	2819	Thread Take-up Crank for 173566 ... ..
173545	2819	Thread Take-up Lever Link for 173563 ... ..
173547	2818	Feed Throw-out Knob Shaft and Bobbin Winder Spool Pin ... ..
+173548	2816	Hand Wheel (spoked), 2½" pulley, for 191K2 Machine ... ..
173551	2820	Shuttle Race Gate Hinge Pin for 171541 and 171542 ... ..
173552	26007	Tension (graduated), complete, Nos. 45352, 45865, 45873, 66774, 125334, 125416, 125421, 173556 and two 219j ... ..
173553	2819	Thread Take-up Lever Hinge Stud for 173563
173554	2819	Needle Bar Connecting Stud with 51363e for 173524 ... ..
173555	2819	Needle Bar Hole Plug ... ..
173556	26007	Tension Releasing Pin for 173552 ... ..
173557	---	Pressure Regulating Thumb Screw 140768zb with 66752 ... ..
173558	2819	Thread Take-up Lever Link Hinge Stud for 173564 ... ..
173559	---	Arm Shaft 173663 with 171509, 171512, 173503 and 173600 ... ..
173563	---	Thread Take-up Lever 45261 with 173545 and 173553 for 173564 ... ..
173564	---	Thread Take-up Lever, complete, Nos. 1130e, 173558 and 173563 for 173565 ... ..
173565	---	Thread Take-up Lever 173564 with 173566
173566	---	Thread Take-up Crank 173542 with 1130e and 173524 for 173565 ... ..
†173572	26002	Face Plate for 173573 ... ..
173573	26002	Face Plate, complete, Nos. 173572, two each 32755 and 173616 (for Two-Tone finish machines) ... ..

+ In ordering it is necessary to state Colour of Machine.

## NUMERICAL LIST OF PARTS

No.	Plate	
173600	2816	Needle Bar Crank with 1036al and 1293al for 173559 ... ..
*173601	—	Arm ... ..
*173602	—	Bed ... ..
173603	2816	Arm Shaft for 173559 ... ..
173608	2819	Needle Bar ... ..
173609	2819	Needle Clamp for 173610 ... ..
173610	2819	Needle Clamp 173609 with 140545c ... ..
173611	2819	Needle Clamp Gib ... ..
173615	26002	Face Plate Thread Guard 32755 with 173616 (for Agents only) ... ..
173616	—	Face Plate Thread Guard Rivet for 173505zb, 173573 and 173615 ... ..